

Owner's Manual

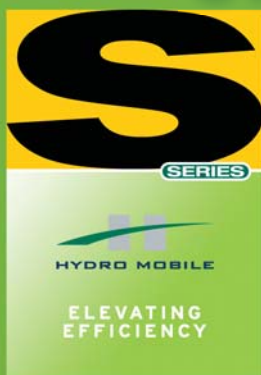

Call us for information:
1-888-484-9376 (US)
(toll free in the United States)
450 589-8100 (Canada)



50053002-0-00000-0
S_OpMan_v2.0_EN

© 2017 by Hydro Mobile Inc. All rights reserved

This manual was produced by Hydro Mobile Inc. on Adobe® InDesign CS5.5® for Windows®.

Technical drawings were prepared using Autodesk Inventor® 2012. Illustrations were created with Autodesk® 3ds Max® v10, Autodesk Inventor® 2012, Adobe® Illustrator CS5.1® for Windows® and Adobe® Photoshop CS5.1® for Windows®.

This manual may not, in whole or in part, be copied, photocopied, reproduced, translated, or converted to any electronic or machine readable form without prior written consent of Hydro Mobile Inc.

NOTE

All assembly and operation instructions located on motorized units and bridges take precedence over information contained in this manual. Should there be any discrepancies discovered throughout any published documentation issued by Hydro Mobile or its authorized affiliates, the following order of precedence shall prevail:

1. Written documents issued by the Hydro Mobile Engineering department
2. Recall instructions
3. Assembly or operation instructions displayed on the motorized unit
4. Owner's manual

Any use of one or several Hydro Mobile motorized units, with or without accessories, in such a configuration or manner as not explicitly described in this manual is not recommended without the prior written permission of Hydro Mobile Inc.

REVISION LIST

Code / Version	Date	Description
50053002-00000-0 v01	March 2017	Addition of method for verification of limit switches and panel alerts; revision of standard bridge assembly instructions; revision of bearing bridge installation and dismantling instructions; introduction of the multi purpose bridge; overall revision of control panel section; clarification on load capacities diagrams on the necessity to have a bridge installed; overall revision of the transport and storage guidelines

LEGEND OF ICONS

These icons are used to highlight important information throughout this manual



Information

Useful information for safe and easy operation



Warning note

An important warning: damage or injury may occur



Useful tip

A useful tip to facilitate installation or operation



Wind speed warning

An important warning: wind speed conditions must be observed to avoid damage or injury



Type of setup

Single unit freestanding installation



Type of setup

Single unit installation with mast ties



Type of setup

Multiple units freestanding installation



Type of setup

Multiple units installation with mast ties

The information and instructions contained in this manual applies to units bearing the following serial numbers

S-0068 and up

GENERAL INFORMATION

Motorized unit serial number _____

Manufacturing date _____



HYDRO MOBILE
www.hydro-mobile.com

125 de l'Industrie
L'Assomption (QC), Canada
J5W 2T9

For orders or information:
1-888-484-9376 (US)
(toll free in the United States)
450 589-8100 (Canada)

TABLE OF CONTENTS

General Information	
Introduction.....	4
Warranty.....	5
Performance and Safety	
Performance and safety rules.....	6
1 – Motorized Unit	
Overview.....	9
List of components included with shipped unit.....	9
Toolbox components.....	9
Operation specifications.....	10
Motorized unit specifications.....	11
Weight of components.....	13
Dimensions.....	14
Positioning.....	14
Minimum bearing surface capacities.....	15
Suggested cribbing.....	15
Setup and configurations.....	16
General guidelines.....	16
Combination of standard and non standard configurations.....	16
Definition of a standard installation.....	16
Methods of installation.....	17
Single unit setups.....	17
Method "A" (progressive).....	20
Method "B" (pre installation of tie levels).....	20
Multiple units setups.....	22
Method "C" (pre installation of tie levels).....	22
Method "D" (pre installation of tie levels).....	26
Dismantling.....	30
Safety guidelines.....	30
Single unit installed using method "A".....	30
Single unit installed using method "B".....	31
Multiple units installed using method "C".....	33
Multiple units installed using method "D".....	34
2 – Safety Devices	
Emergency descent control system.....	36
Installation of the feedback cable.....	36
Centrifugal brakes.....	38
Inclinometer.....	38
Adjustment of the 0° level position.....	38
Verification or limit switches and panel alerts.....	39
Adjusting and resetting the bottom final limit switch.....	39
Adjusting and resetting the top limit switch.....	40
Fall protection.....	41
3 – Bridges	
Standard bridge.....	42
Installation of a bridge.....	42
Storage of a bridge.....	42
Bridge types.....	43
Cartiervier bridge.....	44
Bearing bridge.....	44
Safety guidelines.....	44
Assembly of the bearing bridge structure.....	44
Installation of the twin mast adapter.....	44
Installation of the bearing bridge structure.....	45
Forward/backward extension.....	46
Bridge deck extension.....	47
Swivel bridge.....	48
Installation.....	48
Angle adjustment.....	48
Installation of swivel bridge guardrails.....	49
Front cantilever configurations.....	50
Back cantilever configurations.....	51
Front bearing bridge configurations.....	53
Back bearing bridge configurations.....	55
Counterweight adapter.....	57
Outrigger support assembly.....	59
4 – Power Pack and Components	
General guidelines.....	61
Power cable selection chart.....	61
Installation of the power cable.....	62
Masts of 150' (30,5 m) or less.....	62
Masts over 150' (30,5 m).....	62
Motorized unit startup procedure.....	63
Motorized unit shutdown procedure.....	63
5 – Control Panel	
Description.....	64
Controls.....	64
Screen alerts and instructions.....	65
Unlocking the display screen.....	65
Main menu screen.....	66
F1 – Status info.....	66
F2 – Alerts.....	67
F3 – Inputs and outputs.....	73
F4 – Configuration.....	74

6 – Mast and Mast Ties	
Mast sections.....	75
Installation.....	75
Removal and transport of mast sections.....	76
Mast ties.....	76
General guidelines.....	76
Installation of standard mast ties.....	77
Methods of installation of tie levels.....	78
Mast tie schedules.....	78
Without lateral base extensions.....	78
With lateral base extensions.....	78
Location of perpendicular mast ties.....	79
Recommended order of installation.....	79
Installation of mast ties with extensions.....	80
Additional rigid dual clamps.....	80
Mast tie requirements for plank configurations.....	81
Removal of mast ties.....	81
Anchoring system.....	82
Installation of wall ties.....	83
Wall tie reactions.....	83
Wall tie distance for vertical anchoring installation.....	83
Wall tie types.....	83
Installation guidelines.....	83
Horizontal anchoring.....	78
Fixed wall ties.....	78
Welded wall tie on a beam.....	78
Re-usable wall tie.....	78
7 – Load Capacities	
Load capacity calculation guidelines.....	85
Calculating the maximum number of workers for an installation.....	86
Single unit installation.....	86
Multiple units installation.....	87
Forward extension installation.....	88
Using a standard bridge.....	88
Using a multi purpose bridge.....	88
Swivel bridge installation.....	88
Single unit (0-45 degrees).....	88
Single unit (90 degrees).....	89
Multiple units.....	90
With counterweight adapter.....	91
Hoist installation.....	93
Single unit setup.....	93
Multiple units setup.....	94
8 – Accessories	
Safety Accessories.....	95
Guardrails.....	95
Installation of a standard guardrail.....	95
Face guardrail supports.....	96
Movable guardrail.....	96
Plank-end guardrail.....	96
Universal plank safety support.....	96
Access stairs.....	97
Bridge installation support brackets.....	97
Outriggers.....	98
Description.....	98
Panking configurations.....	98
Outrigger selection table.....	98
Panking configuration guidelines.....	98
Doubled outriggers.....	99
Cross boxes.....	100
Non standard planking configurations.....	100
Non standard planking configuration #1.....	100
Non standard planking configuration #2.....	101
Non standard planking configuration #3.....	101
Outriggers – top position.....	102
Outriggers – bottom position.....	102
Multiple mast handler.....	103
Adapter base for freestanding installation.....	104
Jib arm.....	106
Hoist support assembly.....	107
Monorail.....	108
Weather protection for bridges.....	109
Cable trolley.....	110
9 – Transport, Storage and Maintenance	
Transport and storage.....	113
Preparation of the motorized unit.....	113
Lifting and moving the motorized unit.....	113
Using the forklift tubes.....	113
Using the D-rings.....	114
Using the rear mast head.....	114
Storage of guardrails.....	115
Storage of a bridge.....	115
Storage of the motorized unit.....	115
Inspection and maintenance.....	116
Greasing of rack and gears.....	116
Inspections.....	117
Samples of checklist.....	118

Introduction

Dear owner or user:

Thank you for investing in a Hydro Mobile S Series mast climbing work platform system. The design of these motorized units reflects over a decade of continued field operation, testing and research work and comes as a solution to our company's deepest concern, your safety and well being on the job.

To ensure that the workplace becomes safer and more efficient using a Hydro Mobile system, always have appropriately trained personnel assemble, operate, dismantle and move your mast climbing work platform system. These qualified persons will be required to read this owner's manual and assimilate the information contained herein. Failure to do so could lead to serious injury and/or equipment damage.

These motorized units were designed in accordance with the following standards: US ANSI A92.9-2011, ISO 16369:2007 and EN 1495, 2006/42/CE "directive machine" and 89/336/CEE "directive CEM". Furthermore, these motorized units and the owner's manual comply with US ANSI A92.9-2011 standards, Federal Occupational Safety and Health Administration Standards OSHA 29CFR1926 subpart L; with ISO 16369:2007 and CSA B354.5-07; and with EN 1495, 2006/42/CE "directive machine", 89/336/CEE "directive CEM" and ISO 16369:2007.

To maximize the life expectancy of your equipment and to enjoy years of trouble free operation, we recommend that this Hydro Mobile system be serviced according to maintenance schedules and recommendations provided in this manual. It is also advised to refer to the Honda user's manual included with the motorized unit.

Should you have any questions or concerns, please contact the nearest authorized service center or Hydro Mobile directly at 888-484-9376 (in the United States) or 450 589-8100 (in Canada). You can also visit our Web site at www.hydro-mobile.com for additional support and information on our factory safety and performance training seminars.

We wish you years and years of safe, productive construction and renovation work.

Sincerely,



Vincent Dequoy
President

Warranty

Warranty period

Hydro Mobile Inc., herein referred to as Hydro Mobile, warrants its new S Series motorized units to be free from defect of materials and workmanship for a period of 15 months or a maximum of 650 operating hours whichever occurs first from the date of delivery to the authorized distributor/service center.

Hydro Mobile also warrants its new S Series parts and accessories to be free from defect of materials and workmanship for a period of 15 months from the date of delivery to the authorized distributor/service center.

Product registration

In accordance with standards governing mast climbing work platform systems, the owner of a Hydro Mobile S Series unit must register the product with Hydro Mobile within sixty (60) days. The initial buyer of a Hydro Mobile S Series unit is automatically registered by Hydro Mobile.

Hydro Mobile must be kept informed of any change of ownership. The new owner must provide Hydro Mobile with a full name and address, along with the model and serial number of the unit acquired.

Description of warranty

Parts and accessories manufactured by Hydro Mobile

Hydro Mobile's obligation and liability under this warranty are expressly limited to repairing or replacing with re-manufactured or new parts, at Hydro Mobile's option, any part and accessory manufactured by Hydro Mobile proven defective after inspection by Hydro Mobile which appear to have been defective in material or workmanship. Only permanent repairs will be covered under this warranty. Hydro Mobile reserves the right to ask for maintenance records of the defective part before settling a claim and to deny such claim if maintenance records are not available or not compliant with maintenance schedules.

This warranty shall not apply to component parts or accessories of products not manufactured by Hydro Mobile and which carry the warranty of the manufacturer thereof or to normal maintenance (such as engine tune-up) or any part necessary to perform such maintenance. Hydro Mobile offers no other warranty, expressed or implied, and offers no warranty of merchantability or fitness for any particular purpose.

Motor

All motors and gear boxes manufactured by Nord Gear Limited are covered by an international warranty of 15 months. To have a motor or a gear box repaired under this warranty, the motor or gear box must be brought to an authorized Hydro Mobile distributor/service center.

Costs and liability associated with warranty

Hydro Mobile's obligation under such warranty shall not include duty, taxes or any other charge whatsoever, or any liability for direct, indirect, incidental or consequential damage or delay.

Exclusion

Any use of one or several Hydro Mobile motorized units, with or without accessories, in such a configuration or manner as not explicitly described in the owner's manual is not recommended without the prior written permission of Hydro Mobile.

Any improper use, including operation after discovery of defective or worn parts, shall void this warranty. Improper use also includes operation beyond rated capacity, substitution of parts other than those approved by Hydro Mobile, including anchor systems, or any alteration, modification or repair by others in such manner as in Hydro Mobile's judgment affects the product materially and adversely.

Labor

All warranty work must be performed by a certified Hydro Mobile technician to be eligible for reimbursement under the warranty.

Performance and Safety Rules

SAFETY comes first. The installation and operation of a mast climber is subject to hazards that can be avoided only by using extreme care and common sense, and by providing the **appropriate training and supervision** to all its users.

It is essential that the installation and dismantling of an S Series motorized unit and its related accessories be carried out according to the guidelines, instructions and warnings included in the owner's manual and performed by qualified erectors/dismantlers under the supervision of a competent person (see boxes below).

It is also imperative that the **operation** of an S Series motorized unit setup be carried out according to the guidelines, instructions and warnings included in the owner's manual. To ensure safe and proper operation, Hydro Mobile recommends that **two persons** be on hand to perform maneuvers for **each motorized unit in a setup** and that **at least one of those two persons is a qualified operator** (see box below).

WARNING



The configurations and methods to achieve these configurations for an S Series installation shown and described in this owner's manual are the only ones authorized by Hydro Mobile. For any configuration or method to achieve such a configuration other than those shown and described in this owner's manual, contact the Hydro Mobile technical support team.

WARNING



It is **mandatory** to refer to the *Mast Tie Schedule* tables on p. 77 of the *Mast and Mast Ties* section **before the installation** of any S Series configuration.

Definition of the competent person

Competent person means a person who is capable of identifying existing and predictable hazards in the surroundings or working conditions which are unsanitary, hazardous or dangerous to employees, and who has authorization to take prompt corrective measures to eliminate them.

Definition of the qualified person

"**Qualified**" means a person who, by possession of a recognized degree, certificate or professional standing, or who by extensive knowledge, training and experience, has successfully demonstrated the ability to solve or resolve problems relating to the subject matter, the work or the project.

Only a **qualified person** on the specific make and model of the Hydro Mobile equipment can carry out the following tasks:

User/operator

A **qualified user/operator** is allowed to operate Hydro Mobile units according to the guidelines, instructions, warnings and methods set out in the owner's manuals and Hydro Mobile training courses and after they have been erected, tested and passed for use by a qualified person.

Erector/dismantler

A **qualified erector/dismantler** is allowed to erect, dismantle, test, pass for use and modify the configuration of Hydro Mobile units according to the guidelines, instructions, warnings and methods set out in the owner's manuals and Hydro Mobile training courses.

Technician

A **qualified technician** is allowed to perform maintenance inspections and repairs on Hydro Mobile units according to the guidelines, instructions, warnings and methods set out in the owner's manuals and Hydro Mobile training courses.

Hydro Mobile recommends that Qualified Persons follow the Hydro Mobile University Training Program on the specific task and specific make and model to get proper qualifications. For more information on the Hydro Mobile University Training Program, visit www.hydro-mobile.com/training.

General guidelines

- 1- Prepare a layout plan showing how the mast climbing work platform system (motorized units, bridges and accessories) will be positioned near structures or walls to be erected. On long walls, install separate mast climber sections to allow for flexibility. Make sure to position motorized units so as to provide proper anchoring points for masts for tied installations.
- 2- Rely on a licensed engineer for help on special jobs and to approve plans if required by local regulation.
- 3- It is recommended to use the job survey form as a guide for the proper installation of the configuration. Refer to p. 117 of the *Transport, Storage and Maintenance* section for more information about the job survey form.

Performance and Safety Rules

- 4- It is **mandatory** to refer to the *Mast Tie Schedule* tables on p. 77 of the *Mast and Mast Ties* section and to the *Load Capacities* section on p. 84 **before the installation of any S Series** configuration.
- 5- Establish the distance between the mast climbing work platform system and the structure or wall, taking into account the length of plank outriggers, as well as curvatures, balconies, columns, trees, telephone wires, electrical lines, etc.
- 6- Refer to and follow local regulations governing distances between the mast climbing work platform system and electrical lines. As a reference, North American regulations generally recommend keeping a safe distance of at least 10' (3 m) from overhead power lines carrying 50,000 volts or less.
- 7- Make sure the ground or support surface capacity meets with values included in the *Minimum Bearing Surface Capacities* table herein (fig. 1.20, p. 14). Soil compacting, cribbing or shoring can increase bearing capacity. The **jacks on the base extensions** are designed to level the motorized unit and **must not be used to support the load nor the motorized unit**.
- 8- Never modify the mast climbing work platform system or use substitute factory parts. This could adversely affect worker safety, unit performance and void the warranty. In addition, this could lead to serious injury or death.
- 9- The S Series motorized unit **must not be used** with any equipment or any accessories not specifically manufactured and rated by Hydro Mobile to be used with S Series motorized units. For the use and installation of any such equipment or accessories, contact the distributor/service center or the Hydro Mobile technical support team.
- 10- Each S Series motorized unit must be equipped with an appropriate fire extinguisher (not supplied). Use the support supplied with the motorized unit to hang the fire extinguisher in a readily accessible location (fig. 1.2, p. 8).
- 11- It is recommended not to smoke on the platform.
- 12- Planks used for planking must be scaffold graded (SPF), in good condition and meet local regulations.
- 13- **IMPORTANT:** It is strongly recommended not to use equipment that may generate excessive vibrations or reactions on Hydro Mobile platforms.
- 14- Workers exposed to potential hazards must always wear proper personal protection equipment (PPE) such as a helmet, safety boots, a fall arrest harness, etc., as prescribed by local regulations. In all cases where workers are exposed to fall hazards, fall protection is required. Installation of all the necessary guardrails is **mandatory**. Tie points (D-rings) located on the main trolley of the motorized unit (fig. 1.4, p. 8) are designed to resist to a maximum arrest force of 5000 lb (2268 kg) and can be used by workers to tie themselves to the unit (not more than one worker per D-ring).
- 15- The S Series motorized unit must not be used on a mast with a height over 500' (152 m). The use of the optional cable trolley kit is recommended for mast heights higher than 150' (30,5 m).
- 16- To ensure work efficiency, maintain an adequate equipment and parts inventory on the job site. Keep equipment in good condition.
- 17- Inspection and maintenance operations must be carried out efficiently and in a timely manner. Daily inspections and their related operations must be performed by a **qualified user/operator** every day or before every working shift. Frequent and annual inspections and their related operations must be carried out by a **qualified technician**. Refer to the *Transport, Storage and Maintenance* section on p. 116 for more information on inspection and maintenance requirements for S Series motorized units and their accessories.
- 18- The **qualified erectors/dismantlers** in charge of the installation must make sure that the equipment being installed has been duly inspected and meets all applicable safety standards.
- 19- After installation, mark off limit areas of the system using fencing, barriers, warning tape and note emergency phone numbers (fire and police dept.) for quick reference. **Prepare an emergency evacuation plan that is specific to the job site and is in accordance with local regulations.**

Performance and Safety Rules

- 20- **Never load bridges or motorized units beyond their rated capacities.** Overloading may bring damages to equipment or cause the installation to become unbalanced, leading to serious injury or death.
- 21- Contact the distributor/service center or Hydro Mobile for service, repair or technical advice. Refer to equipment type and serial number when calling.
- 22- Each person should access the platform by the access stairs, a staircase or through an opening in the building. In all cases, transfer must be safe and free from obstruction.
- 23- The use of appropriate fall protection equipment is **mandatory** when modifying plank configuration or whenever the worker is exposed to a fall hazard. Failure to use fall protection equipment can expose the user to serious injury or death. Refer to local regulations for more information.
- 24- When the motorized unit is moving, it is **mandatory** that all workers except the operator stand in an area close to the rear guardrails.
- 25- In the event of an abnormal occurrence or operation which could compromise security (ex. malfunction of a motorized unit component, collision with an obstacle, etc.), immobilize the unit and inform the competent person.
- 26- It is strongly recommended not to touch any of the moving parts on the motorized unit when it is in use.
- 27- All access doors and panels on the motorized unit must be closed when they are not in use. All access doors and panels should be free from any material or obstruction.
- 28- The motorized unit must not be used or operated during an electrical thunderstorm. The motorized unit and its components must not be used as ground for electrical connections.
- 29- The deposit of loads on the setup must be done with extreme care and under proper supervision. Loads must be distributed on all the bridges of the setup, as prescribed by the load capacities charts. Refer to the *Load Capacities* section on p. 84 for more information about placing loads on the platform. When the motorized unit setup is not in use and **above base level**, loads must not be left on the platform except for counterweights.
- 30- In the event of a power outage, it is recommended that all workers remain on the platform as a safety precaution until the power is restored. If the power has not been restored within a reasonable time, the emergency descent system must be used to bring the workers safely back to the nearest safe evacuation point. Refer to p. 35 of the *Safety Devices* section for more information on the use of the emergency descent system.



WARNING - WIND SPEEDS

The **erection** and **dismantling** of a motorized unit setup (including the base, the bridges, the masts, the mast ties and all the other components) must not be conducted when wind speeds exceed **28 mph (45 km/h)**. **Freestanding installations** and **setups equipped with weather protection**, when allowed, must not be used with wind speeds exceeding **28 mph (45 km/h)**. **Weather protection**, when allowed, **must not be used** when work is performed on an **open air structure**. A motorized unit setup with **mast ties must not be operated** when wind speeds exceed **35 mph (56 km/h)**.

When a motorized unit is not in use

- It is mandatory to leave the platform between two tie levels when the motorized unit is not in use.
- Remove all loads from the setup when the motorized unit is not in use.
- It is mandatory to leave all the counterweights applied on the setup in place when the motorized unit is not in use.
- In a freestanding installation, when allowed, the motorized unit must be brought down to base level when not in use.
- If wind speeds are expected to exceed **102 mph (164 km/h)**, the motorized unit must be brought down to base level when not in use.

Motorized Unit Overview

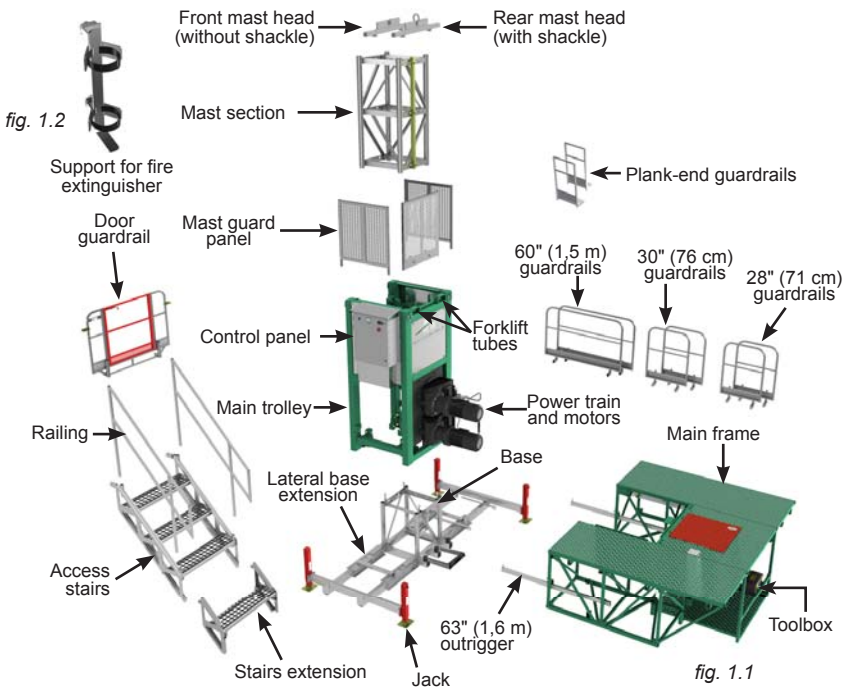

* Only one mast section shipped with each motorized unit.

The configuration represented in the above illustration is for informational purposes only and should not be reproduced without appropriate cribbing under the base.

Note: Items depicted in illustrations may differ from actual products.

List of components included with shipped unit			
Qty	Component	Qty	Component
1	S Series motorized unit	2	28" (71 cm) guardrails
1	owner's manual	2	plank-end guardrails
1	base	12	guardrail "L" adapter brackets
2	base extensions (left and right)	1	access stairs
4	63" (1,6 m) outriggers	2	access stairs ramps
1	mast section	1	access stairs extension
3	mast guard panels	1	door guardrail
2	60" (1,5 m) guardrails	2	mast heads
2	30" (76 cm) guardrails	1	support for fire extinguisher
Note The list of components included with each shipped motorized unit may change without notice.			

Toolbox Components	
Qty	Description
1	15/16" open end wrench
1	cable support kit
1	owner's manual
2	12,5 oz (370 ml) aerosol can of grease for rack and pinion

fig. 1.4

fig. 1.3

Motorized Unit Overview

Access panel on main frame



fig. 1.6

Motorized unit – Rear view

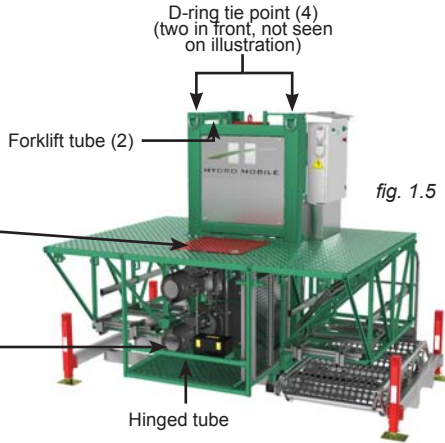

Power train



fig. 1.7



Typical single unit installation

- One S Series motorized unit
- Two (2) 10' (3 m) bridges



Typical multiple unit installation

- Two S Series motorized units
- Two (2) twin mast adapters
- Four (4) 10' (3 m) bridges

fig. 1.8

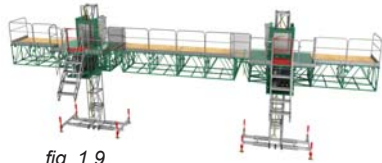

fig. 1.9

fig. 1.10

Operation Specifications	
Wind exposure	
	Maximum wind speed allowed
During operation (of a setup with mast ties)	35 mph (56 km/h)
During erecting and dismantling (all types of setups), for freestanding installations (when allowed) and when unit setup is equipped with weather protection	28 mph (45 km/h)
When unit is out of service	102 mph (164 km/h)
* The S Series motorized unit must not be used on a mast with a height over 500' (152 m).	
Noise exposure	
Standard noise level	
(DB-A / 7 m) @ 3600 rpm	70 dBA

Motorized Unit Specifications

fig. 1.11

General Specifications		
Dimensions of the motorized unit (as shipped)		99" x 147" x 102" (W x L x H) (251 cm x 373 cm x 259 cm)
Drive system		Rack and pinion drive
Maximum height of mast		Height of mast up to 500' (152 m) without prior authorization from Hydro Mobile
Distance between tie levels		Maximum height of mast up to 45' (13,7 m)
Freestanding height of mast (when freestanding is allowed)	No freestanding allowed using regular base	
	Maximum height of mast up to 48' (14,6 m) (including the height of the adapter base) with optional adapter base for freestanding installation (when allowed)	
Safety devices	Emergency descent	Gravity-activated manual descent system
	Feedback cable system (included with twin mast adapter)	Slope detection emergency descent cancellation system
	Centrifugal brake	Centrifugal brake / maximum 34 ft/min (10,4 m/min)
	Inclinometer (included with twin mast adapter)	Slope detection switch

fig. 1.12

Specific Features		
Platform weight (as shipped)	Total	6750 lb (3062 kg) (fully assembled)
Maximum load capacity	Single unit installation	11 200 lb at 10' (5080 kg at 3 m) 5800 lb at 60' (2631 kg at 18 m)
	Multiple units installation	19 450 lb at 50' (8822 kg at 15 m) 1300 lb at 120' (590 kg at 37 m)
Vertical travel speed	240 VAC 60 Hz	30' (9,1 m) /min
	400 VAC 50 Hz	25' (7,6 m) /min
Mast section		28 9/16" x 30" x 60" (72,4 cm x 76,2 cm x 1,5 m) 330 lb (150 kg) per section
Bridges	30" (76 cm)	31" x 62" x 36" (W x L x H) (0,8 m x 1,6 m x 0,9 m)
	5' (1,5 m)	61" x 62" x 36" (W x L x H) (1,5 m x 1,6 m x 0,9 m)
	10' (3 m)	120" x 62" x 36" (W x L x H) (3 m x 1,6 m x 0,9 m)
	Twin mast adapter	32" x 62" x 36" (W x L x H) (0,8 m x 1,6 m x 0,9 m)
Guardrails (included)		28" (0,7 m) (2) 60" (1,5 m) (2) 30" (76 cm) (2)

fig. 1.13

Gear Box Specifications		
Brand		Nord Gear Limited
Model		SK7382
Oil 6.1 US gal (23 L)	Ambient temperature 32°F to 104°F (0°C to 40°C)	Shell Omala S2G 220.
		Mobilgear 600 XP220
	Ambient temperature -22°F to 140°F (-30°C to 60°C)	Shell Omala S4GX 220
		Mobilgear SHC 220
Maximum torque rate		55 630 lb-in (6285 N-m)

Motorized Unit Specifications

fig. 1.14

Electrical Specifications			
		240 V unit	400 V unit
Lifting power	Single unit installation	18 HP	18 HP
	Multiple unit installation	36 HP	36 HP
Power consumption (maximum load)	Single unit installation	1 x 48A	1 x 27,5A
	Multiple unit installation	2 x 48A = 96A	2 x 27,5A = 55A
Input power		240 VAC / 3 ph / 60 Hz (± 5%)	400 VAC / 3 ph / 50 Hz (± 5%)
Control voltage		12 VDC	12 VDC
Starting current (per single unit) (peak)		Up to 240A	Up to 140A
Power outlet for hand tool		1 x 220VAC/20A/60 Hz 1 x 120VAC/20A/60 Hz	2 x 220VAC/20A/50 Hz
Cable up to 500' (152 m)	Single unit installation	1 x 4/4	1 x 6/4
	Multiple unit installation	2 x 4/4	2 x 6/4

fig. 1.15

Motor Specifications		
	240 V unit	400 V unit
Brand	Nord Gear Limited	Nord Gear Limited
Model	SK132S/4 CUS BRE100 HL RG TF	SK132S/4 CUS BRE100 HL RG TF
Rated power	7,5 HP (5,5 KW)	7,5 HP (5,5 KW)
Service factor at full load	1,2	1,2
Rated amperage (nominal)	19,8A	11,8A
Power supply – voltage, phase and frequency	240 VAC / 3/60	400 VAC / 3/50
Rotation speed	1725 rpm	1725 rpm
Braking torque	620 lb-in (70 N-m)	620 lb-in (70 N-m)
Power consumption of motor brake	85W	85 W
IP protection grade	IP65	IP65
Output RPM	8,7 rpm	8,7 rpm

fig. 1.16

Duty Cycle – Mast Climbing Work Platform Application					
% of maximum capacity	Amperage	Service factor	Duty cycle allowed²	Maximum operation time / hour²	Minimum cooling time / hour²
65	39.35 A	1	100%	60 min	0 min
75	41.25 A	1.05	83%	50 min	10 min
90	44.1 A	1.12	42%	25 min	35 min
100	46 A	1.2	25%	15 min	45 min

¹ For 240V units only; for 400V units, contact the Hydro Mobile technical support team
² Based on a maximum outside temperature of 104°F (40°C)



Detailed documentation for the motor can be obtained directly from Nord Gear Limited at www.nord.com/docs by supplying the model number and the serial number of the motor.

Motorized Unit Specifications

fig. 1.17

Weight of Components	
Description	Weight
Motorized unit (as shipped)	6750 lb (3062 kg)
Base assembly (including one mast section and extensions)	1200 lb (544 kg)
Main frame	1300 lb (590 kg)
Power train	2300 lb (1043 kg)
Control panel	150 lb (69 kg)
Main trolley (without the control panel)	1200 lb (544 kg)
Mast assembly (1 rack)	330 lb (150 kg)
Mast guard – SIDE assembly (2 per unit)	32 lb (14,5 kg)
Mast guard – CENTER assembly	41 lb (19 kg)
60" (1,5 m) guardrail assembly (2 per unit)	58 lb (28,4 kg)
33" (84 cm) guardrail assembly	33 lb (15 kg)
30" (76 cm) guardrail assembly (2 per unit)	40 lb (18,1 kg)
28" (71 cm) guardrail (2 per unit)	40 lb (18 kg)
Plank-end guardrail (2 per unit)	23 lb (10 kg)
30" (76 cm) bridge assembly (including guardrail)	290 lb (132 kg)
33" (84 cm) bridge assembly (including guardrail)	310 lb (141 kg)
5' (1,5 m) bridge assembly (including guardrail)	390 lb (177 kg)
10' (3 m) bridge assembly (including guardrail)	720 lb (327 kg)
30" (76 cm) bridge deck extension assembly	96 lb (47 kg)
33" (84 cm) bridge deck extension assembly	57 lb (26 kg)
60" (1,5 m) bridge deck extension assembly	124 lb (61 kg)
Twin mast adapter (with guardrail)	390 lb (177 kg)
Swivel bridge assembly (with guardrail)	800 lb (363 kg)
Swivel counterweight adapter	175 lb (79 kg)
63" (1,6 m) outrigger	20 lb (9 kg)
72" (1,8 m) outrigger	27 lb (12,2 kg)
84" (2,1 m) outrigger	45 lb (22 kg)
120" (3,04 m) outrigger	55 lb (25 kg)
Access stairs assembly	76 lb (34,5 kg)
Access stairs handrails (2)	61 lb (28 kg)
60" (1,5 m) door guardrail assembly	100 lb (45,3 kg)
Hoist support structure (including beam; hoist not included)	417 lb (214 kg)
Adapter base for freestanding installation	2500 lb (1134 kg)
Cable trolley assembly	95 lb (43 kg)
Cable support bracket	5.5 lb (2,5 kg)
Midway cable support bracket	7 lb (3,2 kg)
Cable guide	7 lb (3,2 kg)
Base stopper for cable trolley assembly	42 lb (19 kg)
Weather protection – frame assembly	93 lb (45,5 kg)
Weather protection – X-brace 76 13/16"	7 lb (3,4 kg)
Weather protection – frame truss extension	20 lb (9,8 kg)
Junction plate assembly	19,5 lb (9,5 kg)
Monorail beam	85 lb (41,6 kg)
Trolley for monorail	18 lb (8,8 kg)
Hoist chain block	31 lb (15,2 kg)

Dimensions of the Motorized Unit

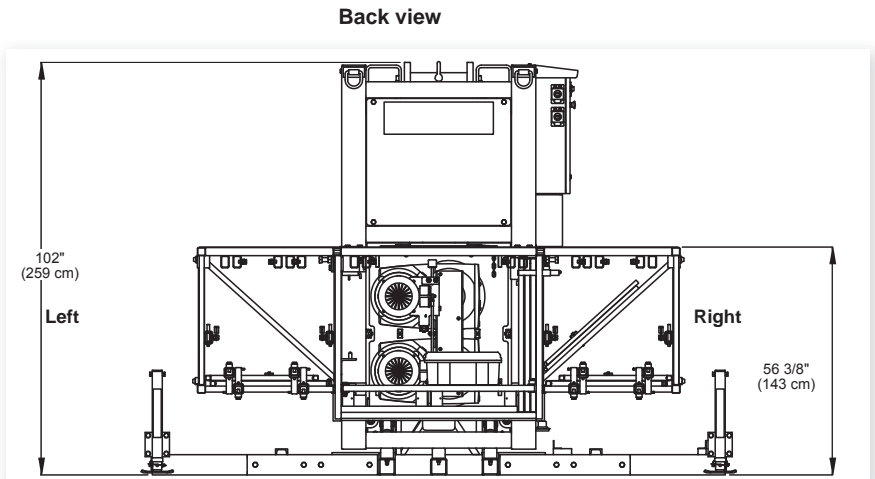
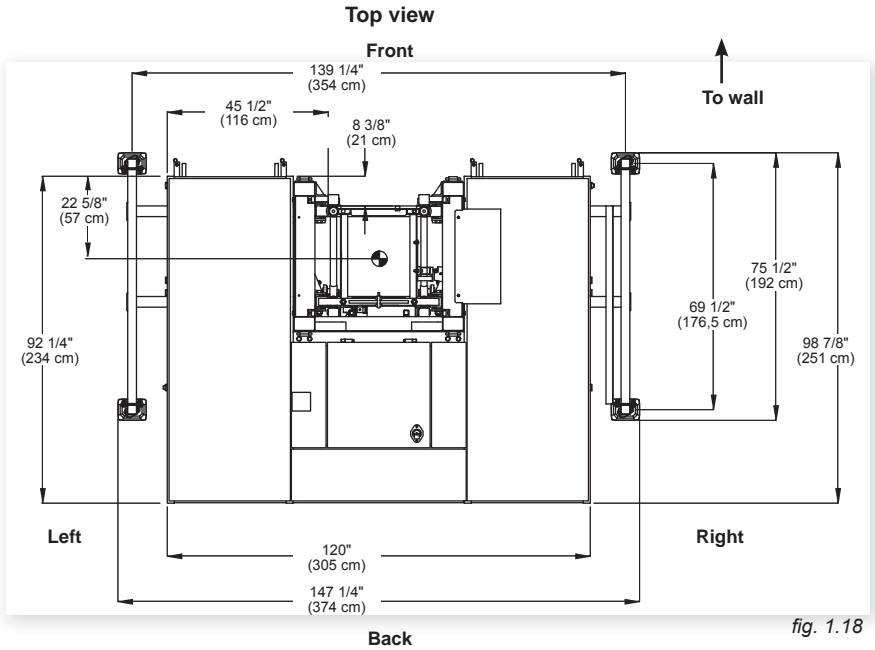

Positioning the Motorized Unit

General Concept

Bearing surface

Before installing the motorized unit, make sure the bearing surface under it is level, clear of debris and has the proper bearing capacity. When required, appropriate cribbing must be placed under the base to distribute the load. It is important to make sure that the bearing surface is stable and has not been subject to any type of erosion or deterioration caused by weather conditions (snow, rain, etc.).

Minimum Bearing Surface Capacities			
Height of mast		Reaction (load under base)	
ft	m	lb	kg
25	7,6	21 875	9922
50	15	23 618	10 713
100	30	27 011	12 252
150	46	30 404	13 791
200	61	33 797	15 330
250	76	37 190	16 869
300	91	40 583	18 408
350	107	43 976	19 947
400	122	47 369	21 486
450	137	50 762	23 025
500	152	54 248	24 606

Note: Reactions shown in this table are for **tyed installations only**

Load reactions in table above include a dynamic factor

fig. 1.20

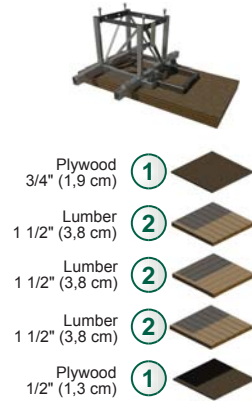

Suggested cribbing for most bearing surfaces

The plywood and lumber used as cribbing should be secured together to prevent slipping. Using screws instead of nails for securing will prolong the service life of lumber and plywood used as cribbing.

The type of cribbing chosen may vary according to the bearing surface where the setup must be installed.

For example, a setup installed on a cement slab that is covering the bearing surface would require cribbing consisting of only one plywood panel under the base and its back extension while a setup installed on a cement slab that is covering an indoor garage would require shoring in addition to plywood cribbing.

A setup installed on a bearing surface composed of gravel, sand or any such type of surface would require stronger cribbing under the base and its back extension. In cases where shoring is required, it is recommended to contact an engineer for assistance.

fig. 1.22

Suggested Cribbing (Under the base and its rear extension)		
40" x 40" x 6" (102 cm x 102 cm x 15,5 cm)		
①	Plywood 40" x 40" x 3/4" (102 cm x 102 cm x 1,9 cm)	2
②	Lumber 2" x 10" x 40" (5 cm x 25 cm x 102 cm)	12

Values shown in the above table are for reference only. Any cribbing equivalent to or larger than these values can be used.



WARNING

Make sure the ground or support surface capacity meets with values included in the *Minimum Bearing Surface Capacities* table (fig. 1.20). Soil compacting, cribbing or shoring can increase bearing capacity. Contact an engineer for assistance.

Setup and Configurations

General Guidelines

Setups with S Series motorized units and bridges require mast ties, unless an optional adapter base for freestanding installation is used. The optional adapter base for freestanding installation can only be used in a standard configuration. A **standard configuration** is an installation that **does not require** the use of additional equipment, such as a forward extension bridge, a swivel bridge or a planking configuration wider than four planks, or the use of accessories such as weather protection, a hoist or a monorail.

It is **mandatory** to refer to the *Mast Tie Schedule* tables on p. 77 of the *Mast and Mast Ties* section **before the installation of any** S Series configuration, whether freestanding or tied.

The installation of an S Series setup with mast ties (standard or non standard configuration) can be achieved using a **progressive installation method** or through complete **pre-installation of tie levels**. The configuration required by the layout plan and the schedule of installation of tie levels will determine which method of installation is more appropriate.

It is also important to consider that the combined use of equipment and accessories required to achieve a non standard configuration may not be allowed on a same installation. Refer to the *Combination of Standard and Non Standard Configurations* table in fig. 1.23 for more information on the combinations allowed.

Combination of Standard and Non Standard Configurations									
Configurations		Standard – Cantilever	Standard – Bearing bridge	4 to 8 planks	Forward/back extension	Swivel bridge	Hoist and support structure	Weather protection	Monorail
		Standard – Cantilever	✓	✓	✓	✓	✓	✓	✓
Standard – Bearing bridge	✓	✓	✓	✓	✓	✓	✓	✓	✓
Equipment	4 to 8 planks	✓	✓	✗	✗	✗	✓	✗	✗
	Forward/back extension	✓	✓	✗	✗	✗	✗	✗	✗
	Swivel bridge	✓	✓	✗	✗	✗	✗	✗	✗
Accessories	Hoist and support structure	✓	✓	✓	✗	✗	✗	✓	✓
	Weather protection	✓	✓	✗	✗	✗	✓	✗	✓
	Monorail	✓	✓	✗	✗	✗	✓	✓	✗
		✓	✓	✗	✗	✗	✓	✓	✗

fig. 1.23



WARNING

Failure to select and follow the mast tie installation schedule appropriate for the configuration could adversely affect worker safety, leading to serious injury or death and equipment damage.

It is **mandatory** to refer to the *Mast Tie Schedule* tables on p. 77 of the *Mast and Mast Ties* section before the installation of any S Series configuration. It is also **mandatory** to refer to the *Load Capacities* section on p. 84 for more information about the loads allowed in a configuration. It is also recommended to review and follow the instructions included in this manual for the installation and use of each accessory and equipment to be installed.



WARNING

It is important to note that freestanding configurations are not allowed for S Series motorized units unless an optional adapter base for freestanding installation is used.

Definition of a standard configuration

A **standard configuration**, referred to throughout this owner's manual and related documentation, is an installation that **does not require** the use of additional equipment, such as a forward extension bridge, a swivel bridge or a planking configuration wider than four planks nor the use of accessories such as weather protection, a hoist or a monorail.

It is **mandatory** to refer to the *Load Capacities* section on p. 84 for the number of bridges allowed in a standard single unit or multiple units installation.

Setup and Configurations

General Guidelines

- 1- Installation should be carried out by qualified erectors/dismantlers under the supervision of a competent person, in accordance with all applicable local regulations.
- 2- In reference to the plan/layout drawing, make sure that all the components required are available. Establish the position of the motorized unit, determine if there are obstacles and what are the cribbing and mast tie requirements.
- 3- Before installing the motorized unit, determine where the cribbing under the base and its back extension will rest. The bearing surface under the cribbing should be level, clear of debris and have the proper bearing capacity (see the *Minimum Bearing Surface Capacities* table, fig. 1.20, p. 14). Should the actual bearing capacity be inferior to the values in the table, please seek instructions and recommendations from Hydro Mobile. It is important to note that **the jacks on the lateral base extensions are designed to level the motorized unit and must not be used to support the load nor the motorized unit.**
- 4- Distance between the front edge of the main frame of the motorized unit and the finished wall should be the number of planks multiplied by the width of one plank, while allowing 6" to 8" (15 to 20 cm) of play. Add an additional 2" (5 cm) if using a toe board. Refer to applicable local regulations to determine play or the maximum allowable distance between the motorized unit, including its accessories, and the face of the work.
- 5- Make sure that all loads have been removed from the platform and that all workers have stepped down before lifting and transporting the motorized unit.
- 6- Unload the motorized unit with a rough terrain forklift or a crane. For more information on the lift and transport of an S Series motorized unit, refer to p. 112 of the *Transport, Storage and Maintenance* section. It is important to consider that an S Series motorized unit that must be lifted has a total weight of 6750 lb (3062 kg).
- 7- Proceed to the following instruction steps for the installation of the setup, as the configuration requires.

Methods of Installation				
Method of installation of tie levels	(A) Progressive installation	(B) Pre-installation	(C) Pre-installation	(D) Pre-installation
Type of installation	Single unit	Single unit	Multiple units	Multiple units
Installation procedure	<ol style="list-style-type: none"> 1. Installation of unit and all cantilever bridges 2. Progressive installation of tie levels 	<ol style="list-style-type: none"> 1. Installation of units and two cantilever bridges 2. Installation of tie levels to top of work 3. Installation of additional bridges, equipment and accessories 	<ol style="list-style-type: none"> 1. Installation of first motorized unit with two cantilever bridges and complete tie levels to top of work 2. Installation of second motorized unit with two cantilever bridges and complete tie levels to top of work 3. Installation of bearing bridge structure 4. Installation of additional bridges, equipment and accessories 	<ol style="list-style-type: none"> 1. Installation of first motorized unit without any bridges 2. Installation of bearing bridge structure 3. Installation of second motorized unit without any bridges 4. Installation of first two cantilever bridges 5. Installation of tie levels to top of the work 6. Installation of additional bridges, equipment and accessories

fig. 1.24



Standard single unit installation with mast ties – progressive installation

(A) The following installation steps can be used for a **single unit standard configuration only**. For more information about the definition of a standard configuration, refer to p. 15 of this section.

Positioning the motorized unit

- 1- Prepare the motorized unit and the area where the setup will be installed as described in the general guidelines (steps 1 through 6 above).
- 2- Align the base of the motorized unit with the face of the work and lower it into position.
- 3- Using the jacks on the lateral base extensions, level the mast on both its front and side axis, then, if required, use metal shims to make sure the base and its back extension sit squarely and level on the cribbing.

Setup and Configurations



Standard single unit installation with mast ties – progressive installation

Connection of the unit and control panel to the power supply

- 4- Select the appropriate power cable for the height of the mast. Refer to the *Power Cable Selection Chart* on p. 60 of the *Power Pack and Operating Components* section for help with the selection of the power cable. Make sure that the overall length of the cable is sufficient for the installation (height of mast, distance from power source, acceptable overall slack in cable).
- 5- Install and connect the power cable. **This installation must be performed by a certified electrician.** For instructions on the installation of the power cable, refer to p. 61 of the *Power Pack and Operating Components* section. It is important to note that if the optional cable trolley kit is required, it must only be installed once the setup is complete to the top of the work. For instructions on the installation and use of the optional cable trolley kit, refer to p. 109 of the *Accessories* section.



WARNING

In a progressive installation, the optional cable trolley kit must only be installed once all tie levels are in place up to the top of the work.

Verification of limit switches, panel alerts and strobe

- 6- Review panel alerts and perform a verification of the limit switches. It is **mandatory** to reset and adjust the bottom final limit switch. **Failure to perform this adjustment will lock the motorized unit and prevent operation.** For instructions on how to reset the bottom final limit switch and verify the other limit switches, refer to p. 38 of the *Safety Devices* section.
- 7- Inspect the strobe under the main frame and make sure it is working appropriately.
- 8- If any of the limit switches is not working properly, call the distributor/service center or the Hydro Mobile technical support team. For more information about limit switches and their corresponding alerts, refer to p. 66 of the *Control Panel* section.



WARNING

Triggering the bottom final limit (BFL) or the top final limit (TFL) will cause a fault of the bottom (or top) final limit circuit: this will **lock the motorized unit and prevent operation.** In such a case, only a qualified erector dismantler or a qualified technician can unlock the motorized unit.

Installation of bridges

- 9- With the motorized unit to base level and using optional bridge installation support brackets or any other appropriate lifting device such as a crane or a rough terrain forklift, install as many bridges as is required and allowed. For instructions on how to install a bridge, refer to p. 41 of the *Bridges* section. Refer to the *Load Capacities* section on p. 84 for the maximum number of bridges allowed in a setup.

It is important to note that at least one tie level must be in place before any loads can be applied on bridges.



Installation of mast sections and the first tie level

- 10- Using an optional jib arm, a crane or a rough terrain forklift, load mast sections on the motorized unit (see p. 105 of the *Accessories* section for more information on the installation and use of the jib arm). There should be a **maximum of four mast sections on each side of the mast at a time.** Mast sections must be **distributed equally on either side of the mast** to ensure good balance.
- 11- Install mast sections until a first tie level is required. Refer to p. 76 of the *Mast and Mast Ties* section for instructions on how to install mast ties. For more information about the schedule of installation of tie levels, refer to the *Mast Tie Schedule* tables on p. 77 of the *Mast and Mast Ties* section.

Installation of the mast heads and the last mast section

- 12- Once all required mast sections and tie levels are in place, install the mast heads. If mast heads are not used, make sure that the last mast section installed is a **one-rack** mast section and that it is installed **backwards**, with the rack facing **toward** the face of the work. Any S Series motorized unit must not be used on a mast with a height over 500' (152 m).

Setup and Configurations



Standard single unit installation with mast ties – progressive installation

Installation of the top limit trigger plate

- 13- Install the top limit trigger plate on the middle bar of the next to last mast section, on the same side as the control panel. To test the operation of the top limit switch, raise the unit until the switch reaches the trigger plate. The panel should display an alert for the top limit. Adjust the top limit switch, if required. If the limit switch is not working properly, call the distributor/service center or the Hydro Mobile technical support team. For more information about limit switches and their corresponding alerts, refer to p. 66 of the *Control Panel* section.

Greasing of the rack(s) and gears

- 14- Upon **initial setup and subsequently after every eight hours of cumulative runtime** (unit travel up and down the mast), grease must be applied to the rack(s) and gears, from the top of the mast down. For more information, refer to the daily inspection checklist recommended for this motorized unit. **Grease must be allowed to stand for 2-3 hours** before the motorized unit is used again. Use an open gear lubricant recommended by Hydro Mobile. Refer to p. 115 of the *Transport, Storage and Maintenance* section for more information on the appropriate lubrication method. Lower the motorized unit to base level, verifying the mast ties and the mast bolts and applying grease, as required, on the way down. Make sure that all bolt assemblies are tightened to the proper torque and are in good condition, and that grease is applied appropriately.

Installation of mast guards

- 15- Once the installation of mast sections and mast ties is complete, bring the unit to base level and install all mast guards. Remove and store the jib arm, if necessary.

Installation of outriggers and planking

- 16- Adjust the outriggers and install planks, as required and allowed (see p. 97 of the *Accessories* section for more information).

Verification of the setup

- 17- Make a final verification of the setup before authorizing workers to use the motorized unit. Make sure the access stairs and all the guardrails are in place and secure (see p. 94 and p. 96 of the *Accessories* section for more information about guardrails and the access stairs). In all cases where workers are exposed to fall hazards greater than specified by local regulations, the installation of guardrails or face guardrail supports is **mandatory**.
- 18- Before authorizing workers to use the motorized unit, perform every step in the daily inspection checklist. If required, fill out the handover sheet to complete the installation. Refer to p. 116 of the *Transport, Storage and Maintenance* section for more information about the daily inspection checklist and to p. 117 for information about the handover sheet.

Adding mast sections and tie levels progressively

- 19- Whenever it is necessary to add mast sections and/or tie levels, remove the mast guards. If the last mast section was installed backwards, remove it and install it properly, making sure the rack is aligned with the rack on the mast section under it. If mast heads were used, remove the mast heads. Remove also the top trigger plate.
- 20- Install as many mast sections and mast ties as is required and allowed (see steps 10 and 11 of the installation procedure). Secure the installation by repeating steps 12 and 13. Install all mast guards and store the jib arm, if necessary. Apply grease to racks and gears when and as recommended in step 14.

For safety reasons, it is mandatory to repeat steps 12 and 13 for each additional mast section installed and to make sure mast guards are put back into place. Grease must be applied to rack(s) and grease when and as recommended in step 14.



Setup and Configurations

Single unit installation with mast ties – pre-installation



The following installation steps can be used for **standard** and **non-standard configurations of single unit tied installations**. For more information about the definition of a standard configuration, refer to p. 15 of this section. For more information about the combined use of equipment and accessories in an installation, refer to the *Combination of Standard and Non Standard Configurations* table on p. 15 of this section.

Positioning the motorized unit

- 1- Prepare the motorized unit and the area where the setup will be installed as described in the general guidelines (steps 1 through 6 on p. 16).
- 2- Align the base of the motorized unit with the face of the work and lower it into position.
- 3- Using the jacks on the lateral base extensions, level the mast on both its front and side axis, then, if required, use metal shims to make sure the base and its back extension sit squarely and level on the cribbing.

Connection of the unit and control panel to the power supply

- 4- Select the appropriate power cable for the height of the mast. Refer to the *Power Cable Selection Chart* on p. 60 of the *Power Pack and Operating Components* section for help with the selection of the power cable. Make sure that the overall length of the cable is sufficient for the installation (height of mast, distance from power source, acceptable overall slack in cable).
- 5- Install and connect the power cable. **This installation must be performed by a certified electrician.** For instructions on the installation of the power cable, refer to p. 61 of the *Power Pack and Operating Components* section. It is important to note that if the optional cable trolley kit is required, it must only be installed once the setup is complete to the top of the work. For instructions on the installation and use of the optional cable trolley kit, refer to p. 109 of the *Accessories* section.

Installation of the first cantilever bridges

- 6- Using any appropriate lifting device such as a crane or a rough terrain forklift, **install only one 5' (1,5 m) bridge on each side of the mast.** Refer to the *Bridges* section on p. 41 for instructions on bridge installation.

Verification of limit switches and panel alerts

- 7- Review panel alerts and perform a verification of the limit switches. It is **mandatory** to reset and adjust the bottom final limit switch. **Failure to perform this adjustment will lock the motorized unit and prevent operation.** For instructions on how to reset the bottom final limit switch and verify the other limit switches, refer to p. 38 of the *Safety Devices* section.
- 8- Inspect the strobe under the main frame and make sure it is working appropriately.
- 9- If any of the limit switches is not working properly, call the distributor/service center or the Hydro Mobile technical support team. For more information about limit switches and their corresponding alerts, refer to p. 66 of the *Control Panel* section.



WARNING

Triggering the bottom final limit (BFL) or the top final limit (TFL) will cause a fault of the bottom (or top) final limit circuit: this will **lock the motorized unit and prevent operation**. In such a case, only a qualified erector dismantler or a qualified technician can unlock the motorized unit.

Installation of mast sections and the first two tie levels

- 10- Using an optional jib arm, a crane or a rough terrain forklift, load mast sections on the motorized unit (see p. 105 of the *Accessories* section for more information on the installation and use of the jib arm). There should be a **maximum of four mast sections on each side of the mast at a time.** Mast sections must be **distributed equally on either side of the mast** to ensure good balance.



WARNING

During pre-installation, only mast sections can be loaded on the motorized unit and the two cantilever bridges. It is important to note that no other loads are allowed on the bridges until the pre-installation process is complete.

Setup and Configurations

Single unit installation with mast ties – pre-installation



Installation of mast sections and the first two tie levels (cont'd)

- 11- Install mast sections until a first tie level is required. Refer to p. 76 of the *Mast and Mast Ties* section for instructions on how to install mast ties. For more information about the schedule of installation of tie levels, refer to the *Mast Tie Schedule* tables on p. 77 of the *Mast and Mast Ties* section. Proceed with the installation of mast sections until the first two tie levels are in place.

Installation of a hoist

- 12- Once the first two tie levels are installed, install a hoist, if required and allowed. It is important to note that during pre-installation, the hoist can be used **only** to handle mast sections and cannot be used above the last tie level installed. For information on the installation and use of the hoist structure, refer to p. 106 of the *Accessories* section.



WARNING

During pre-installation, the hoist can **only** be used to load mast sections. It is important to note that the hoist cannot be used above the last tie level installed.

Completing the installation of mast sections and tie levels

- 13- Proceed with the installation of as many mast sections and tie levels as is required by the layout plan and the configuration. Any S Series motorized unit must not be used on a mast with a height over 500' (152 m).

Installation of the last mast section and the mast heads

- 14- Install the mast heads on top of the last mast section. If mast heads are not used, make sure that the last mast section installed is a **one-rack** mast section and that it is installed **backwards**, with the rack facing **toward** the face of the work.

Installation of the top limit trigger plate

- 15- Install the top limit trigger plate on the middle bar of the next to last mast section, on the same side as the control panel. To test the operation of the top limit switch, raise the unit until the switch reaches the trigger plate. The panel should display an alert for the top limit. Adjust the top limit switch, if required. If the limit switch is not working properly, call the distributor/service center or the Hydro Mobile technical support team. For more information about limit switches and their corresponding alerts, refer to p. 66 of the *Control Panel* section.

Installation of the optional cable trolley

- 16- If required by the height of the mast, proceed with the installation of the optional cable trolley kit. For instructions on the installation of the cable trolley and its components, refer to p. 109 of the *Accessories* section.

Greasing of the rack(s) and gears

- 17- Upon **initial setup and subsequently after every eight hours of cumulative runtime** (unit travel up and down the mast), grease must be applied to the rack(s) and gears, from the top of the mast down. For more information, refer to the daily inspection checklist recommended for this motorized unit. **Grease must be allowed to stand for 2-3 hours** before the motorized unit is used again. Use an open gear lubricant recommended by Hydro Mobile. Refer to p. 115 of the *Transport, Storage and Maintenance* section for more information on the appropriate lubrication method. Lower the motorized unit to base level, verifying the mast ties and the mast bolts and applying grease, as required, on the way down. Make sure that all bolt assemblies are tightened to the proper torque and are in good condition, and that grease is applied appropriately.

Installation of the mast guards

- 18- Once the installation of mast sections and mast ties is complete, bring the unit to base level and install all mast guards. Remove and store the jib arm, if necessary.

Setup and Configurations

Single unit installation with mast ties – pre-installation



Installation of additional bridges, equipment and accessories

- 19- With the unit at base level, install as many additional bridges as is required and allowed. Refer to the *Load Capacities* section on p. 84 for the maximum number of bridges allowed in a setup.
- 20- Install additional equipment and accessories as is required and allowed. For information about the combined use of equipment and accessories allowed for a configuration, refer to p. 15 of this section. For instructions on the installation and use of an extension bridge or a swivel bridge, refer to the *Bridges* section on p. 41. For instructions on the installation and use of any other accessory such as a monorail or weather protection, refer to the *Accessories* section on p. 94.

Installation of outriggers and planking

- 21- Adjust the outriggers and install planks, as required and allowed (see p. 97 of the *Accessories* section for more information).

Verification of the setup

- 22- Make a final verification of the setup before authorizing workers to use the motorized unit. Make sure the access stairs and all the guardrails are in place and secure (see p. 94 and p. 96 of the *Accessories* section for more information about guardrails and the access stairs). In all cases where workers are exposed to fall hazards greater than specified by local regulations, the installation of guardrails or face guardrail supports is **mandatory**.
- 23- Before authorizing workers to use the motorized unit, perform every step in the daily inspection checklist. If required, fill out the handover sheet to complete the installation. Refer to p. 116 of the *Transport, Storage and Maintenance* section for more information about the daily inspection checklist and to p. 117 for information about the handover sheet.

Multiple units installation with mast ties – pre-installation

(requires two twin mast adapters – sold separately)



The following installation steps can be used for **standard and non-standard configurations of tied installations with multiple units linked by a bearing bridge**. For more information about the definition of a standard configuration, refer to p. 15 of this section. For more information about the combined use of equipment and accessories in an installation, refer to the *Combination of Standard and Non Standard Configurations* table on p. 15 of this section.

C

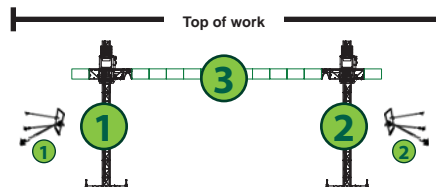

fig. 1.25

Installation of the first motorized unit

1

Positioning the first motorized unit

- 1- Prepare the motorized unit and the area where the setup will be installed as described in the general guidelines (steps 1 through 6 on p. 16).
- 2- Align the base of the motorized unit with the face of the work and lower it into position.

Setup and Configurations



Multiple units installation with mast ties – pre-installation (requires two twin mast adapters – sold separately)

Positioning the first motorized unit (cont'd)

- 3- Using the jacks on the lateral base extensions, level the mast on both its front and side axis, then, if required, use metal shims to make sure the base and its back extension sit squarely and level on the cribbing.

Connection of the unit and control panel to the power supply

- 4- Select the appropriate power cable for the height of the mast. Refer to the *Power Cable Selection Chart* on p. 60 of the *Power Pack and Operating Components* section for help with the selection of the power cable. Make sure that the overall length of the cable is sufficient for the installation (height of mast, distance from power source, acceptable overall slack in cable).
- 5- Install and connect the power cable. **This installation must be performed by a certified electrician.** For instructions on the installation of the power cable, refer to p. 61 of the *Power Pack and Operating Components* section. It is important to note that if the optional cable trolley kit is required, it must only be installed once the setup is complete to the top of the work. For instructions on the installation and use of the optional cable trolley kit, refer to p. 109 of the *Accessories* section.

Installation of the first cantilever bridges

- 6- Using any appropriate lifting device such as a crane or a rough terrain forklift, **install only one 5' (1,5 m) bridge on each side of the mast.** Refer to the *Bridges* section on p. 41 for instructions on bridge installation.

Verification of limit switches and panel alerts

- 7- Review panel alerts and perform a verification of the limit switches. It is **mandatory** to reset and adjust the bottom final limit switch. **Failure to perform this adjustment will lock the motorized unit and prevent operation.** For instructions on how to reset the bottom final limit switch and verify the other limit switches, refer to p. 38 of the *Safety Devices* section.
- 8- Inspect the strobe under each main frame and make sure it is working appropriately.
- 9- If any of the limit switches is not working properly, call the distributor/service center or the Hydro Mobile technical support team. For more information about limit switches and their corresponding alerts, refer to p. 66 of the *Control Panel* section.



WARNING

Triggering the bottom final limit (BFL) or the top final limit (TFL) will cause a fault of the bottom (or top) final limit circuit: this will lock the motorized unit and prevent operation. In such a case, only a qualified erector dismantler or a qualified technician can unlock the motorized unit.

Installation of mast sections and the first two tie levels

- 10- Using an optional jib arm, a crane or a rough terrain forklift, load mast sections on the motorized unit (see p. 105 of the *Accessories* section for more information on the installation and use of the jib arm). There should be a **maximum of four mast sections on each side of the mast at a time.** Mast sections must be **distributed equally on either side of the mast** to ensure good balance.
- 11- Install mast sections until a first tie level is required. Refer to p. 76 of the *Mast and Mast Ties* section for instructions on how to install mast ties. For more information about the schedule of installation of tie levels, refer to the *Mast Tie Schedule* tables on p. 77 of the *Mast and Mast Ties* section. Proceed with the installation of mast sections until the first two tie levels are in place.



WARNING

During pre-installation, the hoist can **only** be used to load mast sections. It is important to note that the hoist cannot be used above the last tie level installed.

Setup and Configurations



Multiple units installation with mast ties – pre-installation (requires two twin mast adapters – sold separately)

Installation of a hoist

- 12- Once the first two tie levels are installed, install a hoist, if required and allowed. It is important to note that during pre-installation, the hoist can be used **only** to handle mast sections and cannot be used above the last tie level installed. For information on the installation and use of the hoist structure, refer to p. 106 of the *Accessories* section.

Completing the installation of mast sections and tie levels

- 13- Proceed with the installation of as many mast sections and tie levels as is required by the layout plan and the configuration. Any S Series motorized unit must not be used on a mast with a height over 500' (152 m).

Installation of the last mast section and the mast heads

- 14- Install the mast heads on top of the last mast section. If mast heads are not used, make sure that the last mast section installed is a **one-rack** mast section and that it is installed **backwards**, with the rack facing **toward** the face of the work.

Installation of the top limit trigger plate

- 15- Install the top limit trigger plate on the middle bar of the next to last mast section, on the same side as the control panel. To test the operation of the top limit switch, raise the unit until the switch reaches the trigger plate. The panel should display an alert for the top limit. Adjust the top limit switch, if required. If the limit switch is not working properly, call the distributor/service center or the Hydro Mobile technical support team. For more information about limit switches and their corresponding alerts, refer to p. 66 of the *Control Panel* section.

Installation of the optional cable trolley

- 16- If required by the height of the mast, proceed with the installation of the optional cable trolley kit. For instructions on the installation of the cable trolley and its components, refer to p. 109 of the *Accessories* section.

Greasing of the rack(s) and gears

- 17- Upon **initial setup and subsequently after every eight hours of cumulative runtime** (unit travel up and down the mast), grease must be applied to the rack(s) and gears, from the top of the mast down. For more information, refer to the daily inspection checklist recommended for this motorized unit. **Grease must be allowed to stand for 2-3 hours** before the motorized unit is used again. Use an open gear lubricant recommended by Hydro Mobile. Refer to p. 115 of the *Transport, Storage and Maintenance* section for more information on the appropriate lubrication method. Lower the motorized unit to base level, verifying the mast ties and the mast bolts and applying grease, as required, on the way down. Make sure that all bolt assemblies are tightened to the proper torque and are in good condition, and that grease is applied appropriately.

Installation of the mast guards

- 18- Once the installation of mast sections and mast ties is complete, bring the unit to base level and install all mast guards. Remove and store the jib arm, if necessary.



WARNING

It is important to make sure to plug in all inclinometers and to enable the inclinometer option on each panel of the bearing bridge installation. It is also essential to perform the 0-degree level adjustment for each inclinometer.



WARNING

It is suggested that two persons handle all rise and descent operations of each motorized unit and that at least **one** of those two persons is a **qualified operator**. It is important to coordinate the motion of motorized units linked by a bearing bridge to keep the structure as level as possible.

Setup and Configurations



Multiple units installation with mast ties – pre-installation (requires two twin mast adapters – sold separately)

2

Installation of the second motorized unit

Positioning and installing the second motorized unit

- 1- Assemble the bearing bridge structure following the safety guidelines and steps 1 through 4 of the instructions for the assembly of a bearing bridge structure on p. 43 of the *Bridges* section. Measure the length of the assembled bearing bridge structure.
- 2- Determine the position of the second motorized unit according to the length of the bearing bridge to be installed.
- 3- Install the second motorized unit following steps 1 through 18 of the installation instructions for the first motorized unit, starting on p. 21.

3

Completing the multiple units installation

Installation of the bearing bridge structure

- 1- Proceed with the installation of the bearing bridge structure following steps 1 through 8 of the instructions for the installation of a bearing bridge structure on p. 43 of the *Bridges* section.

Installation of additional bridges, equipment and accessories

- 2- With the unit at base level, install as many additional cantilever bridges as is required and allowed. Refer to the *Load Capacities* section on p. 84 for the maximum number of bridges allowed in a setup.
- 3- Install additional equipment and accessories as is required and allowed. For information about the combined use of equipment and accessories allowed for a configuration, refer to p. 15 of this section. For instructions on the installation and use of an extension bridge or a swivel bridge, refer to the *Bridges* section on p. 41. For instructions on the installation and use of any other accessory such as a monorail or weather protection, refer to the *Accessories* section on p. 108.

Installation of outriggers and planking

- 4- Adjust the outriggers and install planks, as required and allowed (see p. 97 of the *Accessories* section for more information).

Verification of the setup

- 5- Make a final verification of the setup before authorizing workers to use the motorized units. Make sure the access stairs and all the guardrails are in place and secure (see p. 94 and p. 96 of the *Accessories* section for more information about guardrails and the access stairs). In all cases where workers are exposed to fall hazards greater than specified by local regulations, the installation of guardrails or face guardrail supports is **mandatory**.
- 6- Before authorizing workers to use the motorized units, perform every step in the daily inspection checklist. If required, fill out the handover sheet to complete the installation. Refer to p. 116 of the *Transport, Storage and Maintenance* section for more information about the daily inspection checklist and to p. 117 for information about the handover sheet.



WARNING

During pre-installation, when weather protection is required and allowed, tarps and shields must only be installed once all tie levels are in place up to the top of the work.

Setup and Configurations



Multiple units installation with mast ties – pre-installation (requires two twin mast adapters – sold separately)

D

The following installation steps can be used for **standard and non-standard configurations of tied installations with multiple units linked by a bearing bridge**. For more information about the definition of a standard configuration, refer to p. 15 of this section. For more information about the combined use of equipment and accessories in an installation, refer to the *Combination of Standard and Non Standard Configurations* table on p. 15 of this section.

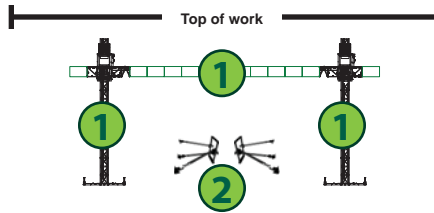

fig. 1.26

Installation of units and bridges

Positioning the first motorized unit

- 1- Prepare the first motorized unit and the area where the setup will be installed as described in the general guidelines on (steps 1 through 6 on p. 16).
- 2- Align the base of the motorized unit with the face of the work and lower it into position.
- 3- Using the jacks on the lateral base extensions, level the mast on both its front and side axis, then, if required, use metal shims to make sure the base and its back extension sit squarely and level on the cribbing.

Installation of the bearing bridge structure

- 4- Prepare and assemble the bearing bridge structure as described in the safety guidelines, the instructions for the assembly of a bearing bridge structure and steps 1 and 2 of the instructions for the installation of a twin mast adapter, starting on p. 43 of the *Bridges* section.
- 5- Using a rough terrain forklift, a crane or any other appropriate lifting device, lift the bearing structure, align it with the motorized unit installed and lower it into position.
- 6- Bolt the twin mast adapter to the main frame of the first motorized unit. For installation instructions, refer to p. 41 of the *Bridges* section.

Positioning the second motorized unit

- 7- Prepare the second motorized unit and the area where the setup will be installed as described in the general guidelines on (steps 1 through 6 on p. 16).
- 8- Align the motorized unit with the end of the bearing bridge structure lower it into position, making sure the base is properly aligned with the face of the work.
- 9- Using the jacks on the lateral base extensions, level the mast on both its front and side axis, then, if required, use metal shims to make sure the base and its back extension sit squarely and level on the cribbing.
- 10- Bolt the twin mast adapter to the main frame of the second motorized unit.

Completing the installation of the bearing bridge

- 11- Complete the installation of the bearing bridge structure as described in steps 3 through 8 of the installation instructions on p. 44 of the *Bridges* section.



WARNING

It is important to make sure to plug in all inclinometers and to enable the inclinometer option on each panel of the bearing bridge installation. It is also essential to perform the 0-degree level adjustment for each inclinometer.

Setup and Configurations



Multiple units installation with mast ties – pre-installation (requires two twin mast adapters – sold separately)

Installation of the first cantilever bridges

- 12- Using any appropriate lifting device such as a crane or a rough terrain forklift, **install only one 5' (1,5 m) bridge** at the cantilever end of each motorized unit. For instructions on the installation of a bridge, refer to p. 41 of the *Bridges* section.



WARNING

It is suggested that two persons handle all rise and descent operations of each motorized unit and that at least **one** of those two persons is a **qualified operator**. It is important to coordinate the motion of motorized units linked by a bearing bridge to keep the structure as level as possible.

Connection of the units and control panels to the power supply

- 13- Select the appropriate power cables for the height of the mast. Refer to the *Power Cable Selection Chart* on p. 60 of the *Power Pack and Operating Components* section for help with the selection of the power cables. Make sure that the overall length of each cable is sufficient for the installation (height of mast, distance from power source, acceptable overall slack in cable).
- 14- Install and connect the power cables. **This installation must be performed by a certified electrician**. For instructions on the installation of power cables, refer to p. 61 of the *Power Pack and Operating Components* section. It is important to note that if optional cable trolley kits are required, they must only be installed once the setup is complete to the top of the work. For instructions on the installation and use of the optional cable trolley kit, refer to p. 109 of the *Accessories* section.

Verification of limit switches and panel alerts

- 15- Review panel alerts and perform a verification of all the limit switches on each motorized unit. It is **mandatory** to reset and adjust the bottom final limit switch. **Failure to perform this adjustment will lock the motorized unit and prevent operation**. For instructions on how to reset the bottom final limit switch and verify the other limit switches, refer to p. 38 of the *Safety Devices* section.
- 16- Inspect the strobe under each main frame and make sure it is working appropriately.
- 17- If any of the limit switches is not working properly, call the distributor/service center or the Hydro Mobile technical support team. For more information about limit switches and their corresponding alerts, refer to p. 66 of the *Control Panel* section.



WARNING

Triggering the bottom final limit (BFL) or the top final limit (TFL) will cause a fault of the bottom (or top) final limit circuit: this will **lock the motorized unit and prevent operation**. In such a case, only a qualified erector dismantler or a qualified technician can unlock the motorized unit.

Installation of mast sections and the first two tie levels

- 18- Using an optional jib arm, a crane or a rough terrain forklift, load mast sections on **each motorized unit** (see p. 105 of the *Accessories* section for more information on the installation and use of the jib arm). There should be a **maximum of four mast sections on either side of each mast at a time**. Mast sections must be **distributed equally on both sides of each mast** to ensure good balance.
- 19- Install mast sections until a first tie level is required. Refer to p. 76 of the *Mast and Mast Ties* section for instructions on how to install mast ties. For more information about the schedule of installation of tie levels, refer to the *Mast Tie Schedule* tables on p. 77 of the *Mast and Mast Ties* section. Proceed with the installation of mast sections until **the first two tie levels are in place on each motorized unit**.



WARNING

It is important to verify limit switches and panel alerts on both motorized units as **simultaneously as possible**.

Setup and Configurations



Multiple units installation with mast ties – pre-installation (requires two twin mast adapters – sold separately)

Installation of hoists

- 20- Once the first two tie levels are installed, hoists can be installed, as required and allowed. It is important to note that during pre-installation, a hoist can be used **only** to handle mast sections and cannot be used above the last tie level installed. For information on the installation and use of the hoist structure, refer to p. 106 of the *Accessories* section.



WARNING

During pre-installation, the hoist can **only** be used to load mast sections. It is important to note that the hoist cannot be used above the last tie level installed.

Completing the installation – mast sections, tie levels and additional equipment and accessories

2

Completing the installation of mast sections

- 1- Proceed with the installation of as many mast sections and tie levels **on each motorized unit** as is required by the layout plan and the configuration. Any S Series motorized unit must not be used on a mast with a height over 500' (152 m).



WARNING

During pre-installation, only mast sections can be loaded on a motorized unit, on the first 5' (1,5 m) of bridge installed at each cantilever end, and on the first 5' (1,5 m) at each end of a bearing bridge structure, for a **maximum of four mast sections on either side of a mast at all times**. It is important to note that no other loads are allowed on the bridges until the pre-installation process is complete.

Installation of the last mast sections and the mast heads

- 2- Install the mast heads on top of the last mast section **on each motorized unit**. If mast heads are not used on either one of the units, make sure that the last mast section installed is a **one-rack** mast section and that it is installed **backwards**, with the rack facing **toward** the face of the work.

Installation of the top limit trigger plates

- 3- Install the top limit trigger plate on the middle bar of the next to last mast section **on each motorized unit**, on the same side as the control panel. To test the operation of the top limit switches, raise the units until the switch reaches the trigger plate. Each panel should display an alert for the top limit. Adjust each top limit switch, as required. If any of the limit switches is not working properly, call the distributor/service center or the Hydro Mobile technical support team. For more information about limit switches and their corresponding alerts, refer to p. 66 of the *Control Panel* section.

Installation of the optional cable trolleys

- 4- If required by the height of the mast, proceed with the installation of optional cable trolley kits. For instructions on the installation of the cable trolley and its components, refer to p. 109 of the *Accessories* section.

Setup and Configurations



Multiple units installation with mast ties – pre-installation (requires two twin mast adapters – sold separately)

Greasing of the racks and gears

- 5- Upon **initial setup and subsequently after every eight hours of cumulative runtime** (unit travel up and down the mast), grease must be applied to the rack(s) and gears, **on each motorized unit** from the top of the mast down. For more information, refer to the daily inspection checklist recommended for this motorized unit model. **Grease must be allowed to stand for 2-3 hours** before the motorized unit is used again. Use an open gear lubricant recommended by Hydro Mobile. Refer to p. 115 of the *Transport, Storage and Maintenance* section for more information on the appropriate lubrication method. Lower the motorized units to base level, verifying the mast ties and the mast bolts and applying grease, as required, on the way down. Make sure that all bolt assemblies are tightened to the proper torque and are in good condition, and that grease is applied appropriately.

Installation of the mast guards

- 6- Once the installation of mast sections and mast ties is complete, make sure the units are at base level and install all mast guards. Remove and store each jib arm, if necessary.

Installation of additional bridges, equipment and accessories

- 7- With the units at base level, install as many additional cantilever bridges as is required and allowed. Refer to the *Load Capacities* section on p. 84 for the maximum number of bridges allowed in a setup.
- 8- Install additional equipment and accessories as is required and allowed. For information about the combined use of equipment and accessories allowed for a configuration, refer to p. 15 of this section. For instructions on the installation and use of an extension bridge or a swivel bridge, refer to the *Bridges* section on p. 41. For instructions on the installation and use of any other accessory such as a monorail or weather protection, refer to the *Accessories* section on p. 94.

Installation of outriggers and planking

- 9- Adjust the outriggers and install planks, as required and allowed (see p. 97 of the *Accessories* section for more information).

Verification of the setup

- 10- Make a final verification of the setup before authorizing workers to use the motorized units. Make sure the access stairs and all the guardrails are in place and secure (see p. 94 and p. 96 of the *Accessories* section for more information about guardrails and the access stairs). In all cases where workers are exposed to fall hazards greater than specified by local regulations, the installation of guardrails or face guardrail supports is mandatory.
- 11- Before authorizing workers to use the motorized units, perform every step in the daily inspection checklist. If required, fill out the handover sheet to complete the installation. Refer to p. 116 of the *Transport, Storage and Maintenance* section for more information about the daily inspection checklist and to p. 117 for information about the handover sheet.



WARNING

It is suggested that two persons handle all rise and descent operations of each motorized unit and that at least **one** of those two persons is a **qualified operator**. It is important to coordinate the motion of motorized units linked by a bearing bridge to keep the structure as level as possible.

Setup and Configurations

Dismantling an installation

SAFETY comes first. It is essential that the **dismantling** of an S Series motorized unit setup be carried out by qualified erectors/dismantlers under the supervision of a **competent person** and be performed with the same care and precaution taken during the installation. It is mandatory to make sure that the motorized unit installation remains stable and secure throughout the dismantling maneuvers. For the definition of a qualified erector/dismantler, refer to p. 5 of the *Performance and Safety* section.

Safety guidelines for dismantling an installation

- 1- Make sure all the equipment necessary for a safe dismantlement of the installation is on hand (slings, crane or rough terrain forklift, etc., as required).
- 2- Inspect all safety devices (centrifugal brake, inclinometers and feedback cables in a bearing bridge configuration, emergency descent, etc.) and make sure that they are working properly.
- 3- It is important to note that any installed **monorail must not be used** during dismantling operations.
- 4- Tarps and shields used for weather protection **must be removed before the start of dismantling operations.**
- 5- It is important to consider that any installed hoist can **only** be used to unload mast sections and cannot be used above the last tie level installed.
- 6- Perform every step in the daily inspection checklist. Refer to p. 116 of the *Transport, Storage and Maintenance* section for more information about the daily inspection checklist.
- 7- Make sure to choose the dismantling method appropriate for the installation. For instructions on the dismantling of an installation using an adapter base for freestanding installation, refer to p. 103 of the *Accessories* section for dismantling guidelines.



WARNING

It is **mandatory** to make sure that **all tension (or compression) is released** from the mast tie before attempting to unpin it from the wall tie.

Dismantling a standard single unit installation with mast ties



The following dismantling steps can be used for a **single unit configuration installed following method of installation "A"**. Refer to p. 16 of this section for more information about method of installation "A".

- 1- Prepare the installation as described in the safety guidelines for dismantling an S Series installation above.
- 2- Bring the motorized unit to the top of the work, verifying mast bolts and mast ties on the way up. Make sure that all mast bolts are tightened at the appropriate torque and that all mast ties are properly tied to the face of the work.
- 3- If a cable trolley was used for the installation, make sure the motorized unit is at the top of the work and bring the platform down to base level, removing cable trolley components on the way down.
- 4- Make sure the motorized unit is at the top of the work. Lower the motorized unit to base level, removing mast sections and mast ties on the way down, **leaving two tie levels in place.** Refer to p. 75 of the *Mast and Mast Ties* section for instructions on how to remove and transport mast sections. Refer to p. 81 of the *Mast and Mast Ties* section for instructions on how to remove mast ties.

Setup and Configurations



Dismantling a standard single unit installation with mast ties

- A**
- 5- Mast sections should be stored and distributed equally on each side of the mast to ensure good balance. Make sure to avoid overloading the unit. On higher installations, it may be required to use a crane to remove mast sections to avoid any overloads. Refer to the *Load Capacities* section on p. 84 of for more information about loads allowed on a platform.
 - 6- When **only two tie levels are remaining**, it is important to **proceed with extreme care** to make sure that the stability of the motorized unit is not compromised during the operation.



Before removing the last two tie levels, it is critical to make sure that the base configuration of the motorized unit is consistent with the tie schedule used for the installation of that motorized unit.

Once the stability of the motorized unit has been secured, proceed with the removal of the last mast sections and tie levels.

- 7- Once the unit is at base level, turn off the main disconnect switch and remove any installed accessory such as hoist, monorail and weather protection structure.
- 8- Remove all loads from the platform and make all workers step down.

**WARNING**

During dismantling, a hoist can only be used to unload mast sections and cannot be used above the last tie level installed.

- 9- Remove all planking, push in all outriggers and secure in place. Remove and store all guardrails.
- 10- Remove the hoist, if required, and all installed bridges (standard, swivel, forward/back extension) on each side of the motorized unit.
- 11- Disconnect the power cable from the motorized unit and the power source. **This operation must be performed by a certified electrician.** Store the power cable properly.
- 12- If the unit is to be stored for any significant length of time, refer to p. 112 of the *Transport, Storage and Maintenance* section for instructions on how to properly store an S Series motorized unit.



Dismantling a single unit installation with mast ties

B

The following dismantling steps can be used for a **single unit configuration installed following method of installation "B"**. Refer to p. 16 of this section for more information about method of installation "B".

- 1- Prepare the installation as described in the safety guidelines for dismantling an S Series installation, on p. 29.
- 2- Bring the motorized unit to base level and remove all loads from the platform.
- 3- With the unit at base level, remove any installed equipment (such as wider planking configuration, swivel bridge, forward/back extension bridge).

**WARNING**

Tarps and shields used for weather protection **must be removed before the start of dismantling operations**. Any installed monorail must not be used during dismantling operations.

Setup and Configurations



Dismantling a single unit installation with mast ties

- 4- Remove any installed accessory (such as monorail, weather protection, etc.) except the hoist, if required.
- 5- Remove all bridges installed, leaving **only one 5' (1,5 m) bridge at each cantilever end** of the motorized unit.
- 6- Bring the motorized unit to the top of the work, verifying mast bolts and mast ties on the way up. Make sure that all mast bolts are tightened at the appropriate torque and that all mast ties are properly tied to the face of the work.
- 7- If a cable trolley was used for the installation, make sure the motorized unit is at the top of the work and bring the platform down to base level, removing cable trolley components on the way down.
- 8- Make sure the motorized unit is at the top of the work. Lower the motorized unit to base level, removing mast sections and mast ties on the way down, **leaving two tie levels in place**. Refer to p. 75 of the *Mast and Mast Ties* section for instructions on how to remove and transport mast sections. Refer to p. 81 of the *Mast and Mast Ties* section for instructions on how to remove mast ties.
- 9- **Mast sections should be stored and distributed equally on each side of the mast to ensure good balance.** There should be a **maximum of four mast sections on each side of the mast at a time**. If required, use a crane to remove mast sections from the two 5' (1,5 m) bridges attached to the unit to avoid any overloads. Refer to the *Load Capacities* section on p. 84 of for more information about loads allowed on an installation.

**WARNING**

During dismantling, only mast sections can be loaded on the two 5' (1,5 m) cantilever bridges attached to the unit. It is important to note that no other loads are allowed on the bridges until the dismantling process is complete.

- 10- When **only two tie levels are remaining**, it is important to **proceed with extreme care** to make sure that the stability of the motorized unit is not compromised during the operation.



Before removing the last two tie levels, it is critical to make sure that the base configuration of the motorized unit is consistent with the tie schedule used for the installation of that motorized unit.

Once the stability of the motorized unit has been secured, proceed with the removal of the last mast sections and tie levels.

- 11- When the motorized unit is at base level, turn off the main disconnect switch.
- 12- Remove all loads from the platform and make all workers step down.
- 13- Remove all planking, push in all outriggers and secure in place. Remove and store all guardrails.
- 14- Remove the hoist, if required, and the 5' (1,5 m) bridges attached at each end of the unit.
- 15- Disconnect the power cable from the motorized unit and the power source. **This operation must be performed by a certified electrician.** Store the power cable properly.
- 16- If the unit is to be stored for any significant length of time, refer to p. 112 of the *Transport, Storage and Maintenance* section for instructions on how to properly store an S Series motorized unit.

**WARNING**

It is **mandatory** to make sure that **all tension (or compression) is released** from the mast tie before attempting to unpin it from the wall tie.

**WARNING**

Before the start of dismantling operations of a setup installed following installation method "B", it is **mandatory** to uninstall any equipment, accessory or bridge, except a hoist (if required) and **only one 5' (1,5 m) bridge** attached at each end of the motorized unit.

Setup and Configurations

Dismantling a multiple units installation with mast ties

C The following dismantling steps can be used for a **multiple units configuration installed following method of installation “C”**. Refer to p. 16 of this section for more information about method of installation “C”.

- 1- Prepare the installation as described in the safety guidelines for dismantling an S Series installation, on p. 29.
- 2- Bring the motorized units to base level and remove all loads from the platform.
- 3- With the units at base level, remove any installed equipment (such as wider planking configuration, swivel bridge, forward/back extension bridge, etc.).
- 4- Remove any installed accessory (such as monorail, weather protection, etc.) except hoists, if required.
- 5- Remove **all installed cantilever bridges** on each motorized unit, leaving **one 5' (1,5 m) bridge attached directly to each motorized unit**.
- 6- Remove the bearing bridge structure. Refer to p. 44 of the *Bridges* section for instructions on the dismantling of a bearing bridge structure.
- 7- Install a **5' (1,5 m) bridge** at the end of each unit where the bearing bridge structure was installed. Both units should now be of equal length on either side of the mast, as shown in fig. 1.27.

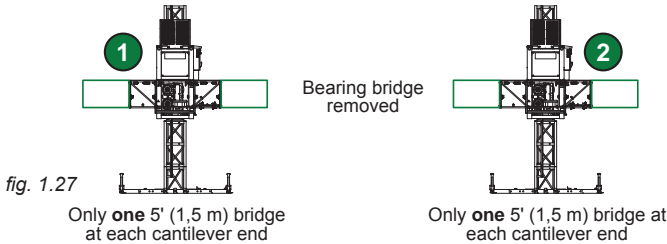

- 8- Bring the first motorized unit to the top of the work, verifying mast bolts and mast ties on the way up. Make sure that all mast bolts are tightened at the appropriate torque and that all mast ties are properly tied to the face of the work.
- 9- If a cable trolley was used for the installation, make sure the motorized unit is at the top of the work and bring the platform down to base level, removing cable trolley components on the way down.
- 10- Make sure the motorized unit is at the top of the work. Lower the motorized unit to base level, removing mast sections and mast ties on the way down, **leaving two tie levels in place**. Refer to p. 75 of the *Mast and Mast Ties* section for instructions on how to remove and transport mast sections. Refer to p. 81 of the *Mast and Mast Ties* section for instructions on how to remove mast ties.
- 11- **Mast sections should be stored and distributed equally on each side of the mast to ensure good balance.** There should be a **maximum of four mast sections on each side of the mast at a time**. If required, use a crane to remove mast sections from the two 5' (1,5 m) bridges attached to the unit to avoid any overloads. Refer to the *Load Capacities* section on p. 84 for more information about loads allowed on an installation.

WARNING

Before the start of dismantling operations of a setup installed following installation method “C”, it is **mandatory** to uninstall any equipment, accessory or bridge, except a hoist (if required) and **only one 5' (1,5 m) bridge** attached at each end of the motorized unit.

WARNING

It is **mandatory** to make sure that **all tension (or compression) is released** from the mast tie before attempting to unpin it from the wall tie.

Setup and Configurations



Dismantling a multiple units installation with mast ties

- 12- When **only two tie levels are remaining**, it is important to **proceed with extreme care** to make sure that the stability of the motorized unit is not compromised during the operation.

Before removing the last two tie levels, it is critical to make sure that the base configuration of each motorized unit is consistent with the tie schedule used for the installation of that motorized unit.



Once the stability of the motorized unit has been secured, proceed with the removal of the last mast sections and tie levels.

- 13- When the motorized unit is at base level, turn off the main disconnect switch.
- 14- Remove any remaining loads (mast sections, mast ties) from the platform and make all workers step down.
- 15- Remove all planking, push in all outriggers and secure in place. Remove and store all guardrails.
- 16- Remove the hoist, if required, and the 5' (1,5 m) bridges attached at each end of the unit.
- 17- Disconnect the power cable from the motorized unit and the power source. **This operation must be performed by a certified electrician.** Store the power cable properly.
- 18- Repeat steps 8 through 17 for the second motorized unit.
- 19- If one or both units are to be stored for any significant length of time, refer to p. 112 of the *Transport, Storage and Maintenance* section for instructions on how to properly store an S Series motorized unit.



WARNING

It is suggested that two persons handle all rise and descent operations of each motorized unit and that at least **one** of those two persons is a **qualified operator**. It is important to coordinate the motion of motorized units linked by a bearing bridge to keep the structure as level as possible.

Dismantling a multiple units installation with mast ties



The following dismantling steps can be used for a **multiple units configuration installed following method of installation "D"**. Refer to p. 16 of this section for more information about method of installation "D".

- 1- Prepare the installation as described in the safety guidelines for dismantling an S Series installation, on p. 29.
- 2- Bring the motorized units to base level and remove all loads from the platform.
- 3- With the units at base level, remove any installed equipment (such as wider planking configuration, swivel bridge, forward/back extension bridge).
- 4- Remove any installed accessory (such as monorail, weather protection, etc.) except hoists, if required.
- 5- Leaving the bearing bridge structure in place, remove **all installed cantilever bridges** on each motorized unit (see 1 and 2 in fig. 1.28, p. 34), leaving **only one 5' (1,5 m) bridge attached at the cantilever end of each motorized unit**.



WARNING

Before the start of dismantling operations of a setup installed following installation method "D", it is **mandatory** to uninstall any equipment, accessory or bridge, except a hoist (if required) and **only one 5' (1,5 m) bridge attached at the cantilever end of each motorized unit, leaving the bearing bridge structure in place** (fig. 1.28, p. 34).

Setup and Configurations

Dismantling a multiple units installation with mast ties

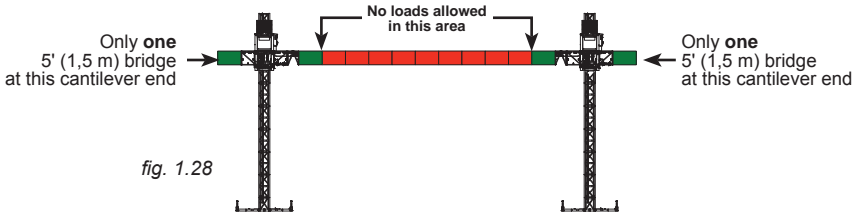

- 6- Bring the motorized units to the top of the work, verifying mast bolts and mast ties on the way up. Make sure that all mast bolts are tightened at the appropriate torque and that all mast ties are properly tied to the face of the work.

**WARNING**

During dismantling, only mast sections can be loaded on a motorized unit, on the first 5' (1,5 m) of bridge installed at each cantilever end, and on the first 5' (1,5 m) at each end of a bearing bridge structure, for a **maximum of four mast sections on either side of a mast at all times**. It is important to note that no other loads are allowed on the bridges until the dismantling process is complete.

- 7- If a cable trolley was used for the installation, make sure the motorized unit is at the top of the work and bring the platform down to base level, removing cable trolley components on the way down.
- 8- Make sure the motorized units are at the top of the work. Lower the motorized units to base level, removing mast sections and mast ties on the way down, **leaving two tie levels in place on each motorized unit**. Refer to p. 75 of the *Mast and Mast Ties* section for instructions on how to remove and transport mast sections. Refer to p. 81 of the *Mast and Mast Ties* section for instructions on how to remove mast ties.
- 9- **Mast sections should be stored and distributed equally on each side of the mast to ensure good balance.** There should be a **maximum of four mast sections on each side of the mast at a time**. If required, use a crane to remove mast sections to avoid any overloads. Refer to the *Load Capacities* section on p. 84 of for more information about loads allowed on an installation.
- 10- When **only two tie levels are remaining**, it is important to **proceed with extreme care** to make sure that the stability of the motorized units is not compromised during the operation.



Before removing the last two tie levels, it is critical to make sure that the base configuration of each motorized unit is consistent with the tie schedule used for the installation of that motorized unit.

Once the stability of each motorized unit has been secured, proceed with the removal of the last mast sections and tie levels **on each motorized unit**.

- 11- When the motorized units are at base level, turn off each main disconnect switch.
- 12- Remove any remaining loads (mast sections, mast ties) from the platform and make all workers step down.
- 13- Remove all planking, push in all outriggers and secure in place. Remove and store all guardrails.
- 14- Remove the hoist(s), if required, and the 5' (1,5 m) bridges attached at the cantilever end of each motorized unit.
- 15- Remove the bearing bridge structure. Refer to p. 44 for instructions on the dismantling of a bearing bridge structure.
- 16- Disconnect the power cable from each motorized unit and the power source. **This operation must be performed by a certified electrician.** Store the power cables properly.
- 17- If one or both units are to be stored for any significant length of time, refer to p. 112 of the *Transport, Storage and Maintenance* section for instructions on how to properly store an S Series motorized unit.

Safety Devices

Emergency Descent Control System

In the event of a power outage or broken parts, use the gravity-activated emergency descent control system to bring the motorized unit safely down to the **nearest safe evacuation point**. It is important to note that the emergency descent system must not be used in the event of damages to a gear box, a brake, a gear or an idler.

In a multiple unit installation, it is mandatory to install 5-degree feedback cables on each motorized unit of the setup.

Installation of the feedback cable

- 1- Remove the bolt assembly on the middle truss of the twin mast adapter on the bearing side (fig. 2.3).
- 2- Install the 0-reference bracket on the truss and secure in place with the bolt assembly (fig. 2.1). Make sure the cable is facing towards the motorized unit.

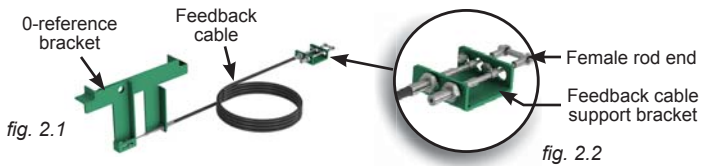

- 3- Install the feedback cable support bracket on the main frame (fig. 2.4) and secure in place with bolt assemblies.
- 4- Using bolt assemblies, attach the female rod end to the bushing on the emergency pedal assembly (fig. 2.5).
- 5- Repeat steps 1 through 4 for each motorized unit of the multiple unit installation. If the unit is located in the middle of a multiple bearing bridge installation, two feedback cables must be installed to provide for each side of the unit (fig. 2.5).

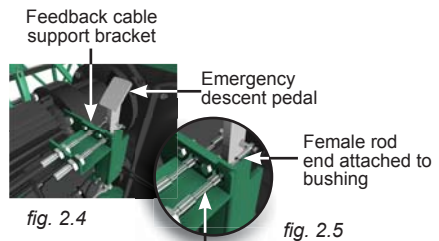
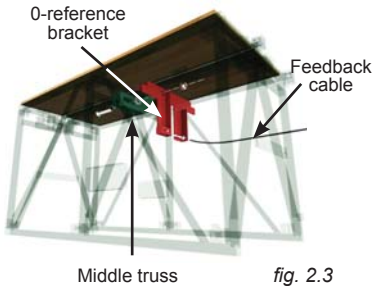

A second cable must be installed if unit is in the middle of a multiple bearing bridge installation

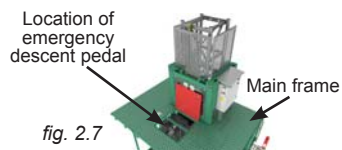
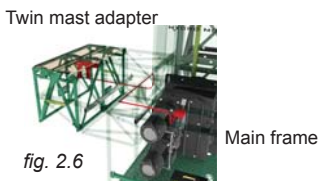

Bracket, cable and support sometimes shown in red for illustration purposes only.

Safety Devices

Emergency Descent Control System

 The following steps must be performed on **each motorized unit of the installation**.



WARNING

In case of doubt regarding the structural integrity of the installation, the emergency descent must not be initiated and the installation must be evacuated following the emergency evacuation plan.

- 1- Turn off the main disconnect switch to shut down the power (fig. 5.1, p. 63). It may be required by local regulations for the operator to be tied to the unit using one of the D-rings on the main frame during the emergency descent.
- 2- In a multiple units installation, make sure that a 5-degree feedback cable kit is properly installed on each motorized unit of installation. It is important to note that since the inclinometers do not work during the emergency descent of a multiple unit structure, any slope of the structure exceeding ± 5 degrees will be detected by the feedback cable. In the event of a slope of the structure exceeding ± 5 degrees, the feedback cable will prevent the use of the emergency descent pedal on the motorized unit at the lowest position until the structure is level again.
- 3- Perform a visual inspection of gears, motor and mast.
- 4- Perform a visual inspection of the structure. In case of **doubt** regarding the **structural integrity** of the installation, the emergency descent **must not be initiated** and the installation must be **evacuated** following the emergency **evacuation plan** (see step 18 of the general guidelines on p. 5 of the *Performance and Safety Rules* section).
- 5- Make sure that outriggers and planking clear the building. Planking must be removed from in front of the mast to clear tie levels during the emergency descent.
- 6- It is important to note that bottom limit sensors and audible alarms do not work during a manual descent of the platform. Make sure that all workers on and off the installation have been warned and that the areas below and around the descending platform have been cleared and remain free of obstacles and workers. It is recommended to monitor carefully the lowering of the platform during the emergency descent.
- 7- Allow the platform to lower for 30' (9,1 m) then release the pedal and **let the centrifugal brakes cool down for 5 minutes** before resuming descent. Proceed in that fashion down to the **nearest safe evacuation point**.
- 8- Open the access panel on the main frame (fig. 2.7, p. 35). Remove the toggle pin to unlock the emergency descent pedal. Step on and hold the emergency descent pedal fully depressed (fig. 2.4, p. 35) to initiate the emergency descent. The platform will descend at a pre-determined speed.



WARNING

During an emergency descent, it is essential to stop the motorized before it reaches the bottom final limit. Triggering the bottom final limit (BFL) will cause a fault of the bottom final limit circuit: this will lock the motorized unit and prevent operation. In such a case, only a qualified erector dismantler or a qualified technician can unlock the motorized unit.

Centrifugal brakes

The Hydro Mobile S Series is equipped with centrifugal brakes. This safety feature is designed to bring the motorized unit and the installation safely down to nearest safe evacuation point at a factory-set speed. It is important to make sure that the brakes are **allowed to cool down for 5 minutes after every 30' (9,1 m) of descent**.

Safety Devices

Inclinometer

Used only in bearing bridge configurations, the inclinometer is located on the twin mast adapter and must **absolutely** be connected to the control panel. The inclinometer will detect any ± 2 -degree slope of the structure and the panel will display an alert message to warn the operator and stop the operation. For more information on the installation and use of a twin mast adapter, see p. 43 of the *Bridges* section. For more information about alert messages, see p. 66 of the *Control Panel* section.

Connection

- 1- Make sure the twin mast adapter is properly bolted to the main frame. Refer to p. 43 of the *Bridges* section for instructions on the installation and use of a twin mast adapter.
- 2- Connect one end of the inclinometer extension cable to the inclinometer.
- 3- Run the inclinometer extension cable through the bottom part of the main frame. Connect the extension cable in the proper inclinometer port under the control panel. If the bearing bridge is to the **left** of the unit, the cable must be connected in the LEFT inclinometer port. If the bearing bridge is located to the **right** of the unit, the cable must be connected in the RIGHT inclinometer port.
- 4- Activate the appropriate inclinometer (LEFT or RIGHT, as determined in step 3) on the panel and perform the adjustment of the 0-degree level position, as described in the instructions below.
- 5- Repeat steps 1 through 4 for the inclinometer at the other end of the bearing bridge (LEFT or RIGHT, as determined in step 3).

Adjustment of the 0° level position

fig. 2.8

- 1- Make sure the bearing bridge structure is level.
- 2- Activate the panel display screen and select the inputs/outputs section (F3) on the main menu screen.
- 3- Navigate to the page where the inclinometer level readings are displayed (fig. 2.8).
- 4- Loosen the adjustment bolt on the LEFT inclinometer sensor (as determined in step 3 of the connection steps above).
- 5- Move the sensor until a 0.00 reading for the LEFT inclinometer is displayed on the screen. Tighten the bolt to secure the sensor in place.
- 6- Repeat steps 2 through 5 to adjust the inclinometer sensor at the other end (RIGHT, as determined in step 3 of the connection steps above).



Detection of a ± 2 -degree slope

- 1- When the motorized unit is moving, if the inclinometer detects a slope of ± 2 degrees, a signal is automatically sent to the control panel and a ± 2 -degree alert message is displayed.
- 2- **If the structure is rising**, the motorized unit that is at the highest level (-2 deg.) in the configuration will automatically stop while the lowest side (+2 deg.) will continue to rise until the structure is brought back to level.
- 3- **If the structure is descending**, the motorized unit that is at the lowest level (+2 deg.) in the configuration will automatically stop while the highest side (-2 deg.) will continue to descend until the structure is brought back to level.

Safety Devices

Verification of limit switches and panel alerts

Preparation of the motorized unit

- 1- Turn on the main disconnect switch, pull out the emergency stop button and unlock the display panel (fig. 2.9). Make sure that the inclinometer and communication options have been disabled on the control panel. Refer to the *Power Pack and Operating Components* section on p. 62 for instructions on how to turn on the main power. For information about the functions and alerts of the control panel, refer to the *Control Panel* section on p. 63.

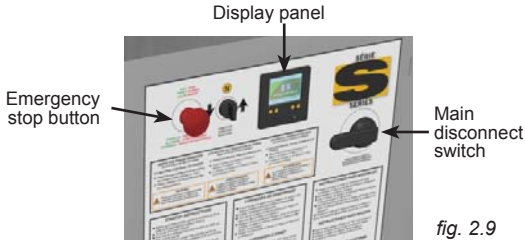

fig. 2.9

Control panel

- 2- Make sure that the control panel does not detect any event that would prevent the safe and appropriate operation of the unit. It is important to note that when the motorized unit is at base level and resting on its buffers, the panel should display an alert for the bottom final limit (BFL). The unit will not be allowed to travel up or down when a BFL alarm is present.

Adjusting and resetting the bottom final limit switch

- 3- Make sure at least one mast section is installed. Refer to p. 74 of the *Mast and Mast Ties* section for instructions on the installation of mast sections.
- 4- Loosen the bolt and raise the bottom limit/bottom final limit (BL/BFL) trigger (see fig. 2.10 and fig. 2.11, p. 39) by about 12" (30 cm). Tighten the bolt to secure the trigger in place.
- 5- Perform a position reset on the display panel to allow the motorized unit to travel upwards. Refer to the *Control Panel* section on p. 63 for instructions on how to perform a position reset on the display panel.
- 6- Raise the motorized unit until it reaches the BL/BFL trigger.
- 7- Loosen the bolt and lower the BL/BFL trigger and set its position so the motorized unit will stop at the proper height above the base. Tighten the bolt to secure the trigger in place.
- 8- Perform a position reset on the display panel to allow the motorized unit to travel downwards.
- 9- With the motorized unit at base level (above the BL/BFL trigger) and the power on, test the top final limit switch by carefully raising the unit above the first mast section. If the switch is working properly, the panel should display an alert and prevent upward travel.

Safety Devices

Verification of limit switches and panel alerts

Adjusting and resetting the bottom limit switch

- 10- Lower the motorized unit to base level until the BL alarm is displayed on the control panel. The control panel will then also display a "TOP FINAL LIMIT" (top final limit fault) alert, preventing the motorized unit to travel upwards.
- 11- Perform a position reset on the LCD display to allow the motorized unit to travel upwards.
- 12- To test the bottom limit switch, raise the motorized unit by about 12" (30 cm) then lower it again. If the switch is working properly, the panel should display an alert and prevent downward travel. Adjust or replace the bottom limit switch, if necessary.

Adjusting and resetting the top limit switch

- 13- Remove the aluminum cover located under the control panel.
- 14- Test the top limit switch by placing a metal object in front of it. If the switch is working properly, the panel should display an alert and prevent upward travel. Adjust or replace the top limit switch, if necessary.
- 15- Replace the aluminum cover.
- 16- If any of the limit switches is not working properly, call the distributor/service center or the Hydro Mobile technical support team. For more information about limit switches and their corresponding alerts, refer to p. 66 of the *Control Panel* section.

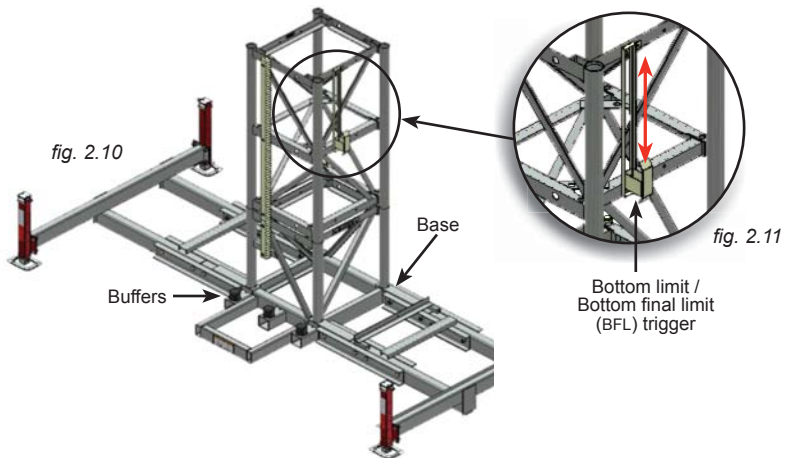

WARNING

Triggering the bottom final limit (BFL) or the top final limit (TFL) will cause a fault of the bottom (or top) final limit circuit; this will lock the motorized unit and prevent operation. In such a case, only a qualified erector dismantler or a qualified technician can unlock the motorized unit.

Safety Devices

Fall Protection

The use of fall protection equipment is **mandatory** for all workers on an S Series motorized unit setup whenever a fall hazard is present. It is recommended to use a combination of full body harness and a shock-absorbing lanyard. It is mandatory to use certified fall protection equipment that is clean and in good working condition. Fall protection equipment should be inspected before each use and be replaced if found to be defective. Refer to the manufacturer's recommendations for more information about the use and care of the selected equipment. Refer also to local regulations for more information about fall protection equipment requirements.

The use of fall protection equipment is **mandatory** when moving planks – for example, when moving planks away from in front of the mast to pass a tie level or to modify the planking configuration.

- 1- Using the designated tie points (D-rings) on the main trolley of the motorized unit (fig. 2.12), an optional fall arrest bracket installed on two guardrails (fig. 2.14) or a cross-arm anchorage strap tied to two guardrails (fig. 2.13), secure the fall protection equipment. The points are designed to resist to a maximum arrest force of 5000 lb (2268 kg) and can be used by workers to tie themselves to the unit (not more than one worker per tie point).
- 2- Move planks in front of the mast to pass a tie level or modify the planking configuration.

Designated tie points on the unit
(D-rings)



Not more than one worker per tie point (D-Ring)



fig. 2.13

Cross-arm anchorage strap
(not manufactured by Hydro Mobile)



fig. 2.14

Fall arrest bracket

Standard bridge

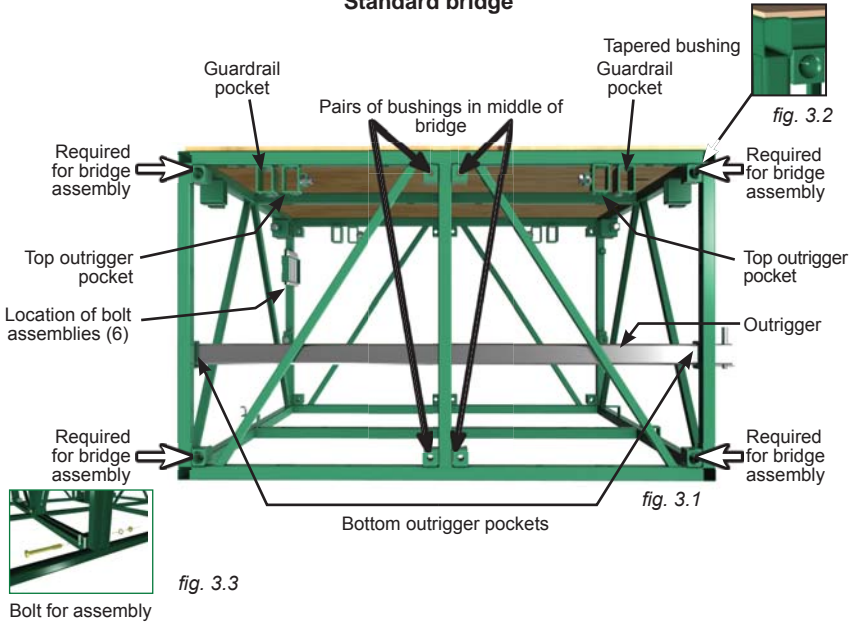

Installation of a bridge

- 1- Align the bridge with the motorized unit or another bridge using the tapered bushings (large white arrows, fig. 3.1).
- 2- Assemble both structures together using **six** bolt assemblies: one 5/8" x 5 1/2" (GR8) hex bolt, one 5/8" (GR8) lock washer and one 5/8" (GR8) nut in each of the four corner tapered bushings and in **one** of the pairs of bushings in the middle of the bridge (using top and bottom bushings on either side – left or right, fig. 3.4). Tighten all bolt assemblies to a torque of 120 b-ft (163 N-m).
- 3- Set up bridges alternately on each side of the mast in such a sequence as to warrant the balance of the structure.

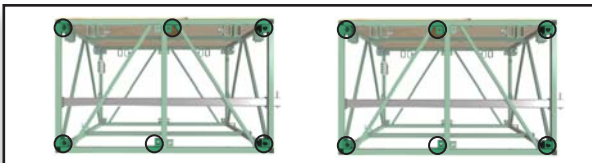

fig. 3.4

Storage of a bridge

- 1- Inspect the structure of the bridge, including the inside of the open-end tubes, for any sign of damage or distortion. Clean the bridge and its components thoroughly to limit the effects of any corrosive agent.
- 2- Bridges must not be stored directly on the ground. Make sure to place sufficient cribbing under the bottom chords to prevent damages to the bottom of the structure.
- 3- Avoid storing the bridge in a location with direct exposure to aggressive or corrosive materials in the surroundings.

Bridges

Bridge Types

5' (1,5 m) bridge



fig. 3.5

Dimensions	60" x 62 1/4" x 35 13/16" (152,4 cm x 158 cm x 91 cm)
Weight	390 lb (177 kg)
Guardrail	1x 60" (1,5 m) – 58 lb (26,3 kg)
Outrigger	1x 2 1/2" x 1 1/2" x 1/8" x 63" long (6,4 cm x 3,8 cm x 0,3 cm x 160 cm)
Bolt and nut set	6x 5/8" x 5 1/2" long (GR8 UNC)

30" (76 cm) bridge



fig. 3.6

Dimensions	30 1/2" x 62 1/4" x 35 13/16" (77,4 cm x 158 cm x 91 cm)
Weight	290 lb (132 kg)
Guardrail	1x 30" (76 cm) – 40 lb (18,1 kg)
Outrigger	1x 2 1/2" x 1 1/2" x 1/8" x 63" long (6,4 cm x 3,8 cm x 0,3 cm x 160 cm)
Bolt and nut set	6x 5/8" x 5 1/2" long (GR8 UNC)

10' (3 m) bridge



fig. 3.7

Dimensions	120" x 62 1/4" x 35 13/16" (305 cm x 158 cm x 91 cm)
Weight	720 lb (327 kg)
Guardrail	2x 60" (1,5 m) – 58 lb (26,3 kg)
Outrigger	2x 2 1/2" x 1 1/2" x 1/8" x 63" long (6,4 cm x 3,8 cm x 0,3 cm x 160 cm)
Bolt and nut set	6x 5/8" x 5 1/2" long (GR8 UNC)

Twin mast adapter



fig. 3.8

Dimensions	30 3/8" x 62 1/4" x 35 13/16" (77,2 cm x 158 cm x 91 cm)
Weight	390 lb (177 kg)
Guardrail	1x twin mast adapter guardrail – 45 lb (20,4 kg)
Accessories	Inclinometer
Bolt and nut set	12x 5/8" x 5 1/2" long (GR8 UNC)

Swivel bridge



fig. 3.9

Dimensions	67 7/8" x 62 1/4" x 39 1/2" (172,4 cm x 158 cm x 100,3 cm)
Weight	800 lb (363 kg)
Guardrail	1x swivel bridge guardrail – 120 lb (54,4 kg)
Bolt and nut set	6x 5/8" x 5 1/2" long (GR8 UNC)

Multi-purpose bridge



Dimensions	33 1/4" x 62 1/4" x 35 13/16" (84,5 cm x 158 cm x 91 cm)
Weight	310 lb (141 kg)
Guardrail	1x 32" (81 cm) – 40 lb (18 kg)
Outrigger	1x 2 1/2" x 1 1/2" x 1/8" x 63" long (6,4 cm x 3,8 cm x 0,3 cm x 160 cm)
Bolt and nut set	4x 5/8" x 4 1/2" long (GR8 UNC)

Bridges

Cantilever Bridge

Installation

- 1- Make sure that both the inclinometer and communication options are disabled on the panel.
- 2- Using any appropriate lifting device such as a crane or a rough terrain forklift, bolt a bridge assembly to the motorized unit on one side of the mast. Refer to p. 41 of this section for instructions on the installation of a bridge. It is important to note that optional bridge support brackets cannot be used to bolt a bridge assembly to the main frame of the motorized unit.
- 3- Bolt a second bridge assembly to the motorized unit, on the other side of the mast. For the second bridge assembly and subsequent bridges allowed to be installed, optional bridge support brackets may be used to lift the bridge to be installed. For more information about the use of optional bridge installation support brackets, refer to p. 96 of the *Accessories* section.
- 4- Install as many additional bridges as required and allowed. It is important to install each bridge alternately on one side, then on the other side of the mast, to avoid throwing the structure out of balance. **The number of bridges should be equal on both sides of a cantilever installation.** Refer to the *Load Capacities* section on p. 84 for information on the number of bridges allowed in a cantilever bridge configuration.

Bearing Bridge

(requires the use of two motorized units and two twin mast adapters)

Safety guidelines

- 1- In a bearing bridge setup (multiple units), it is **mandatory** to install any additional cantilever bridge **after** the bearing bridge structure has been installed to avoid throwing the structure off balance. Dismantle all the components of the structure in reverse order.
- 2- It is suggested that two persons handle all rise and descent operations of each motorized unit and that at least **one** of those two persons is a **qualified operator**. It is important to coordinate the motion of motorized units linked by a bearing bridge to keep the structure as level as possible. Refer to p. 5 of the *Performance and Safety* section for the definition of a qualified operator.
- 3- Daily verification and testing of all the inclinometers are recommended before operating the motorized units (as part of the daily inspection).

Assembly of a bearing bridge structure

- 1- Choose a clear, level surface close to the work area where the bridges can be temporarily set down to assemble the bearing bridge structure. To facilitate assembly, set down wood cribbing or mast sections laid horizontally before lowering the bridges in place.
- 2- Using a rough terrain forklift or a crane, lift and lower a bridge on top of the wood cribbing or the laid down mast sections.
- 3- Lift another bridge and align it carefully with the bridge it must be attached to.
- 4- Assemble the two bridges as described in the instructions on p. 41 of this section.
- 5- Complete the assembly of the bearing bridge structure using as many bridges as is required and allowed. Refer to p. 86 of the *Load Capacities* section for information on the number of bridges allowed in a bearing bridge configuration.

Installation of the twin mast adapter

- 1- Lift and position the twin mast adapter so that the inclinometer is on the **bearing** side of the structure, **opposite to the main frame** (fig. 3.10).
- 2- Using the tapered bushings, align the twin mast adapter with the the bearing bridge structure. If the welded stoppers on the bottom trusses of the last bridge and the twin mast adapter prevent proper alignment, the twin mast adapter is not correctly positioned.
- 3- Using 5/8 x 5 1/2" (GR8) hex bolts, 5/8" (GR8) lock washers and 5/8" (GR8) nuts, attach the twin mast adapter to the bridge and make sure all the bolt assemblies are tight and secure. For instructions on the installation of a bridge, refer to p. 41 of this section.



It is not recommended to have a 30" (76 cm) bridge bolted to the twin mast adapter as the 30" (76 cm) guardrail will interfere with the twin mast adapter guardrail.



Bridges

Bearing Bridge

Installation of the twin mast adapter (cont'd)

- Repeat steps 1 through 3 to attach the second twin mast adapter at the other end of the bearing bridge structure. **The locking plates must not be unhooked at this point.**

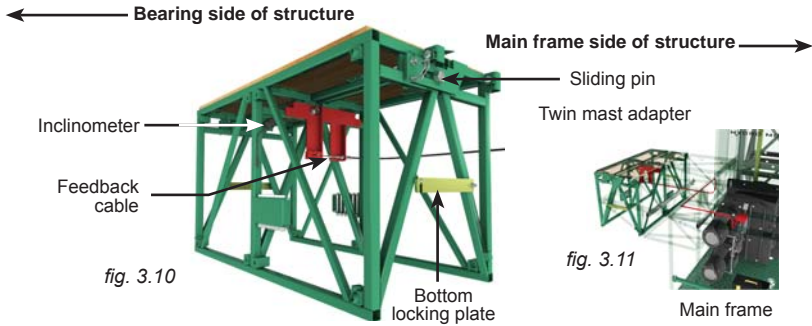

Bracket, cable and support shown in red for illustration purposes.

Installation of the bearing bridge structure

- Using a rough terrain forklift, a crane or any other appropriate lifting device, lift the bearing structure and lower it into position, between the two motorized units.
- Bolt each twin mast adapter to the main frame of the motorized unit.

⚠ Make sure to unlock the locking pins, tabs or plates on each twin mast adapter. Failure to do so could result into serious damages.

- Connect each inclinometer to the control panel. For more information on the use and installation of the inclinometer, see p. 37 of the *Safety Devices* section and the *Control Panel* section, on p. 63.
- Enable the inclinometer option on each panel of the bearing bridge installation. Refer to p. 72 of the *Control Panel* section for instructions on how to enable the inclinometer option.
- Perform the 0-degree level adjustment for each inclinometer. Refer to p. 37 of the *Safety Devices* section for instructions on the 0-degree level adjustment procedure.
- Install and connect each feedback cable required. Refer to p. 35 of the *Safety Devices* section for instructions on the installation and use of feedback cables.
- Install optional communication cables, if required. Enable the communication option on the panel of each of the units linked together by a communication cable. Refer to p. 72 of the *Control Panel* section for more information.
- Install the a twin mast adapter guardrail on each twin mast adapter and secure in place.

Dismantling a bearing bridge structure

- To dismantle a bearing bridge structure, lower both motorized units until the platform is at base level.
- Completely unload the working platform and make workers step off the structure.
- Remove all installed cantilever bridges.
- Disconnect the inclinometers, the feedback cables and the communication cables at both ends of the bearing structure and disable the inclinometer and communication options on each panel.
- Replace the locking pins, tabs or plates on each twin mast adapters.
- Using a rough terrain forklift, a crane or any other appropriate lifting device, support the bearing bridge structure. Unbolt the twin mast adapters from the main frames of the motorized units.
- Slightly raise the bearing bridge and lower it on the ground to dismantle it.

Bridges

Forward/Back Extension Bridge (optional)

The extension bridge (used on the front or on the back of a motorized unit setup) is assembled using a regular bridge, two outriggers and three (3) forward extension plate assemblies.

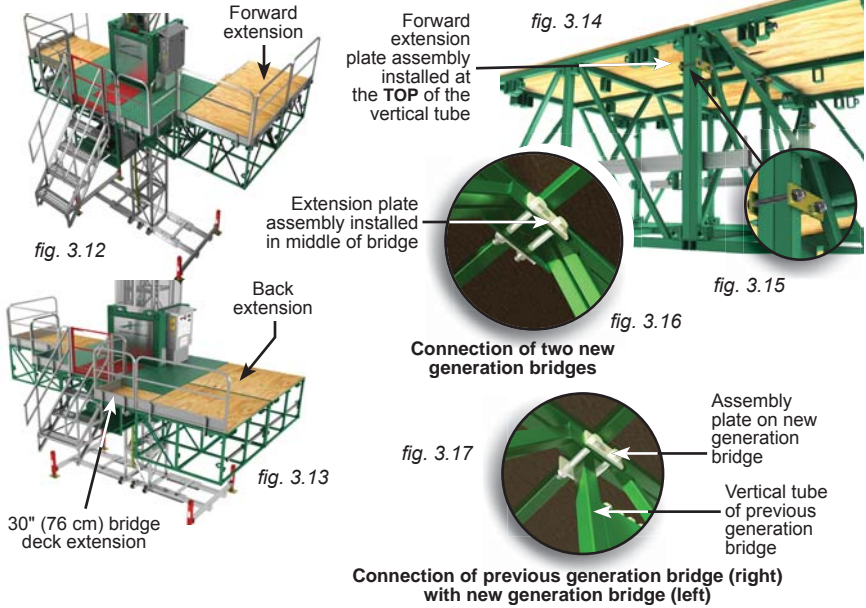

Installation

- 1- Remove the plank stop pins from two outriggers and slide the outriggers in the bottom outrigger pockets of a bridge assembly already installed on the motorized unit, leaving about 6" (15 cm) protruding from the bridge. Do not tighten the bolts.
- 2- Align the bridge that will be used as an extension with the installed bridge and slide the protruding ends of the two outriggers from the bridge assembly in the bottom outrigger pockets of the back or forward extension. Insert a plank stop pin in each outrigger.
- 3- Install the first two forward extension plate assemblies at the **TOP** of each of the two vertical tubes at each end of the bridge assembly (fig. 3.13). If using only previous generation bridges, install the third extension plate assembly on the middle vertical tube of the bridge, secure the bolt assemblies and proceed to step 5.
- 4- If using at least one new generation bridge in the installation, install the third forward extension plate assembly at the **TOP** in the middle of the bridge structure by positioning the plates so the holes align with the holes on the plate in the middle of the bridge structure (fig. 3.17). Secure with bolt assemblies.
- 5- Tighten all bolts to secure the outriggers.
- 6- If the bridge installed will be used as a **back** extension, it is required to attach a 30" (76 cm) bridge deck extension to the inside of the bridge to secure the area close to the unit (fig. 3.15). For instructions on the installation and use of a bridge deck extension, refer to p. 46 of the current section.

Bridges

Forward/Back Extension Bridge (optional)

Installation (cont'd)

- 7- Install the appropriate guardrails on the back or forward extension. Install the necessary guardrails on the deck extension, if required.
- 8- If required, install cross boxes and additional outriggers to plank the inside corner of the bridge used as an extension. For more information on the use and installation of cross boxes, refer to p. 99 of the *Accessories* section.

For more information on the load capacities of forward extensions, refer to p. 87 of the *Load Capacities* section. For any configuration using back extensions or forward extensions not described in this manual, contact the distributor/service center or the Hydro Mobile technical support team.

Bridge Deck Extension (optional)

Bridge deck extensions can be attached to 30" (76 cm), 5' (1,5 m) and 10' (3 m) bridges and are used to extend the width of the work area from 5' (1,5 m) to 7' 6" (2,3 m), increasing the space available for circulation on the setup. To ensure stability, the number of bridge deck extensions installed must be equal on either side of the mast.

Bridge deck extensions **must be used only for the circulation of workers on the setup and must not be used as a storage area for material, tools, equipment or any other load**. The weight of each bridge deck extension installed must be taken into account when calculating the load capacity of a setup. Refer to the *Weight of Components* table on p. 12 of the *Motorized Unit* section.

Unless authorized in writing by Hydro Mobile prior to installation, planking is not allowed when using bridge deck extensions in the front of a setup. For information on the number of bridges allowed in a configuration using bridge deck extensions, contact the distributor/service center or the Hydro Mobile technical support team.

Installation

- 1- Remove the plank stop pins and clevis pins from two outriggers.
- 2- Slide the outriggers in the top outrigger pockets of the bridge and reinstall the clevis pins to prevent the outriggers from slipping out of the outrigger pockets.
- 3- Insert the bridge deck extension on the outriggers and push in the extension until it is snug against the bridge.
- 4- Install the plank stop pins and push in the outriggers until they are snug against the extension.
- 5- Tighten the bolt assemblies of the outrigger pockets both on the deck extension and the bridge to secure the outriggers in place.
- 6- Install the appropriate guardrails on the deck extension.

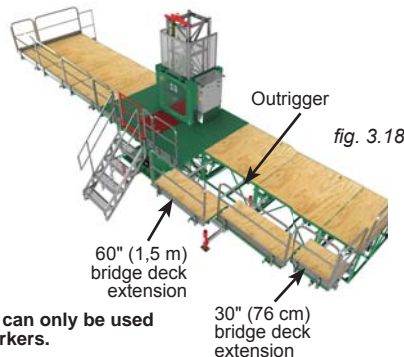

Bridge deck extensions can only be used for the circulation of workers.

Bridges

Swivel Bridge (optional)

The swivel bridge allows creating 0° to 45° configurations, as well as corner (90°) configurations. Certain configurations may require the use of the optional outrigger support system and the optional counterweight adapter. The use of weather protection is not recommended on an installation using a swivel bridge.

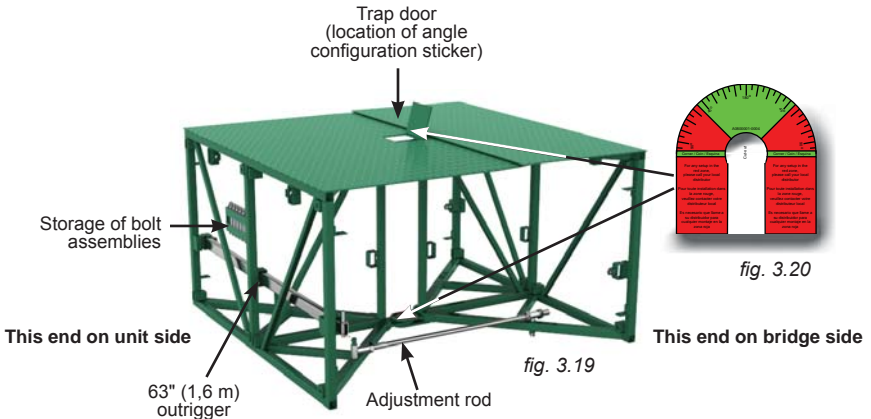

Installation

- 1- Using the tapered bushings, align the proper end of the swivel bridge with the main frame of the motorized unit, as shown in fig. 3.19. If the welded stoppers on the bottom trusses of the main frame and the swivel bridge prevent proper alignment, the swivel bridge is not correctly positioned.
- 2- Attach the swivel bridge to the main frame and make sure all the bolt assemblies are tightened and secure. For instructions on the installation of a bridge, refer to steps 1 and 2 of the standard installation instructions, on p. 41.
- 3- Repeat steps 1 and 2 to attach a standard bridge to the swivel bridge.
- 4- Install as many additional bridges as required and allowed. Refer to the *Load Capacities* section on p. 87 for information on the number of bridges allowed in a swivel bridge configuration.

Angle adjustment

- 1- Make sure that the adjustment rod is installed on the appropriate side of the bridge to achieve the desired configuration. If required, remove the bolt assemblies at both ends of the adjustment rod and reinstall on the other side of the bridge (fig. 3.19).

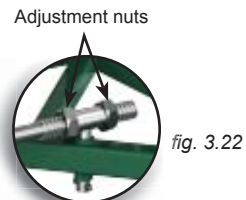
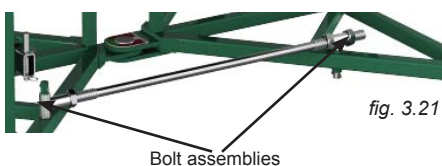

Bridges

Swivel Bridge

Angle adjustment (cont'd)

- 2- Position the swivel bridge installation at the desired angle by turning the adjustment nut. Refer to the angle sticker located under the trap door on the bridge deck or on the pivot pin at the bottom of the bridge (fig. 3.20, p. 47) to make sure the installation is at an appropriate angle. Unless authorized in writing by Hydro Mobile prior to installation, a swivel bridge configuration may only be installed at an angle between 0 and 45 degrees or at exactly 90 degrees. For any configuration between 45 and 90 degrees (red areas on the angle configuration sticker), contact the distributor/service center or the Hydro Mobile technical support team.

Installation of swivel bridge guardrails

Swivel bridge installations require the use of special guardrails, included with each shipped swivel bridge. The installation of guardrails on a swivel bridge will depend on the angle of the configuration. Guardrails used in the configuration will also be different whether the swivel bridge is used in a **cantilever bridge** or a **bearing bridge** installation.

Since not all swivel bridge guardrails may be necessary for a given configuration, refer to specific instructions for each configuration for the assembly of the appropriate guardrails.

It is important to note that swivel bridge guardrails must not be used as a tie-off point.

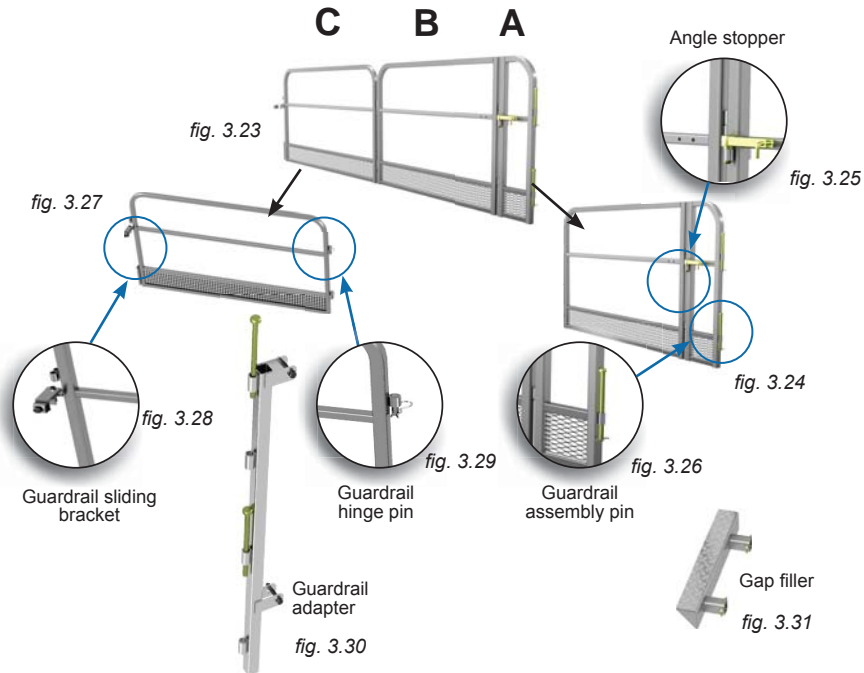

WARNING

Swivel bridge guardrails must not be used to tie a lifeline.

Bridges

Swivel Bridge

Cantilever Configurations

Front cantilever configurations (0 to 45° and 90°)

- 1- Make sure that the adjustment rod is installed on the appropriate side of the bridge to achieve the desired configuration. If required, remove the bolt assemblies at both ends of the adjustment rod and reinstall it on the other side of the bridge (fig. 3.19, p. 47).
- 2- Lock the angle pivot between parts "A" and "B" of the swivel bridge guardrail assembly at 0° using the angle stopper (fig. 3.25, p. 48).
- 3- Align the plates of the guardrail adapter (fig. 3.33) with the **side** of the 28" (71 cm) guardrail on the main frame of the unit and secure in place with bolts.
- 4- Align the hinge tubes on the swivel bridge guardrail assembly with the hinge tubes on the adapter on the 28" (71 cm) guardrail and secure in place with guardrail assembly pins (fig. 3.33).
- 5- Insert the guardrail hinge pins on part "C" in the corresponding hinge tubes on part "B". Secure the assembly with hairpin cotter pins.
- 6- Install a 60" (1,5 m) regular guardrail on the bridge attached to the swivel bridge.
- 7- Secure part "C" of the swivel bridge guardrail assembly to the 60" (1,5 m) guardrail by tightening the bolt on the sliding bracket (fig. 3.32).
- 8- Make sure all the necessary guardrails are in place and secure (see the *Accessories* section on p. 94 for more information about guardrails). In all cases where workers are exposed to fall hazards greater than specified by local regulations, the installation of guardrails or face guardrail supports is **mandatory**.

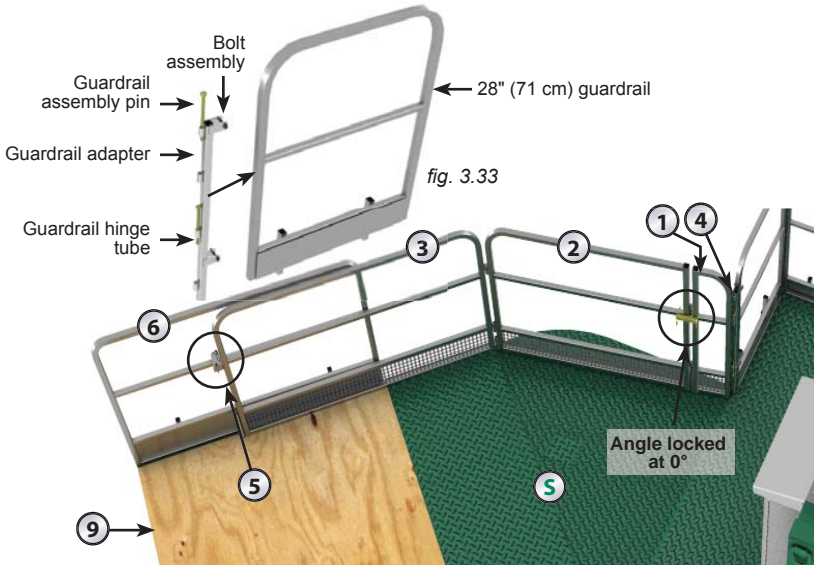

Front 0 to 45° cantilever configurations

fig. 3.32

LEGEND

- | | | | |
|---|--|--------------------------------------|----------------------------|
| <p>① Part "A" of swivel bridge guardrail assembly</p> | <p>④ Guardrail adapter</p> | <p>⑦ Twin mast adapter guardrail</p> | <p>⑩ Twin mast adapter</p> |
| <p>② Part "B" of swivel bridge guardrail assembly</p> | <p>⑤ Sliding bracket to secure guardrails together</p> | <p>⑧ Gap filler</p> | <p>Ⓢ Swivel bridge</p> |
| <p>③ Part "C" of swivel bridge guardrail assembly</p> | <p>⑥ Standard 60"(1,5 m) guardrail</p> | <p>⑨ 5' (1,5 m) bridge</p> | |

Bridges

Swivel Bridge

Cantilever Configurations

Back 0 to 45° cantilever configurations

- 1- Make sure that the adjustment rod is installed on the appropriate side of the bridge to achieve the desired configuration. If required, remove the bolt assemblies at both ends of the adjustment rod and reinstall it on the other side of the bridge (fig. 3.19, p. 47).
- 2- Lock the angle pivot between parts "A" and "B" of the swivel bridge guardrail assembly at 90° using the angle stopper (fig. 3.34).
- 3- Align the plates of the guardrail adapter (fig. 3.33, p. 49) with the **side** of the 28" (71 cm) guardrail on the main frame of the unit and secure in place with bolts.
- 4- Align the tubes on the swivel bridge guardrail assembly with the tubes on the adapter on the 28" (71 cm) guardrail and secure in place with guardrail pins (fig. 3.33, p. 49).
- 5- Insert the guardrail assembly pins on part "C" in the corresponding tubes on part "B". Secure the assembly with cotter pins.
- 6- Install a 60" (1,5 m) regular guardrail on the bridge attached to the swivel bridge.
- 7- Secure part "C" of the swivel bridge guardrail assembly to the 60" (1,5 m) guardrail by tightening the bolt on the sliding bracket (fig. 3.34).
- 8- Verify and make sure to remove any gap there may be on the deck.

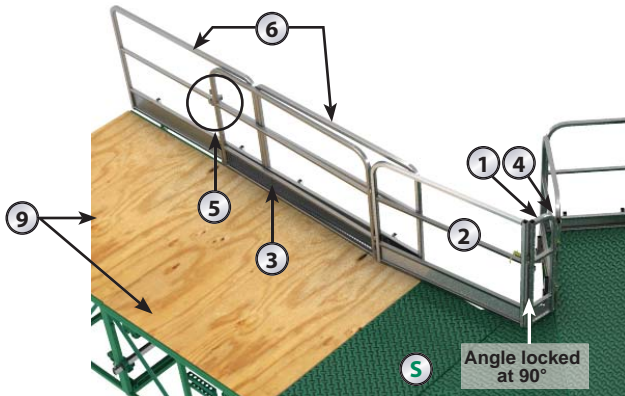

fig. 3.34

Back 0 to 45° cantilever configurations

- 9- Make sure all the necessary guardrails are in place and secure (see the *Accessories* section on p. 94 for more information about guardrails). In all cases where workers are exposed to fall hazards greater than specified by local regulations, the installation of guardrails or face guardrail supports is **mandatory**.

LEGEND

① Part "A" of swivel bridge guardrail assembly	④ Guardrail adapter	⑦ Twin mast adapter guardrail	⑩ Twin mast adapter
② Part "B" of swivel bridge guardrail assembly	⑤ Sliding bracket to secure guardrails together	⑧ Gap filler	Ⓢ Swivel bridge
③ Part "C" of swivel bridge guardrail assembly	⑥ Standard 60"(1,5 m) guardrail	⑨ 5' (1,5 m) bridge	

Bridges

Swivel Bridge

Cantilever Configurations

Back 90° cantilever configuration

- 1- Make sure that the adjustment rod is installed on the appropriate side of the bridge to achieve the desired configuration. If required, remove the bolt assemblies at both ends of the adjustment rod and reinstall it on the other side of the bridge (fig. 3.19, p. 47).
- 2- Part "B" of the swivel bridge guardrail assembly is not required for 90° back cantilever configurations. Separate all three parts ("A", "B" and "C") of the swivel bridge guardrail assembly, if necessary.
- 3- Assemble part "A" and "C" of the swivel bridge guardrail assembly.
- 4- Align the plates of the guardrail adapter (fig. 3.36) with the **front** of the 30" (76 cm) guardrail on the main frame of the unit and secure in place with bolts.
- 5- Align the tubes on the swivel bridge guardrail assembly with the tubes on the adapter on the 30" (76 cm) guardrail and secure in place with guardrail pins (fig. 3.36).
- 6- Install the gap filler (fig. 3.35) to fill the gap on the deck.
- 7- Install a 60" (1,5 m) regular guardrail on the bridge attached to the swivel bridge.
- 8- Secure part "C" of the swivel bridge guardrail assembly to the 60" (1,5 m) guardrail by tightening the bolt on the sliding bracket (fig. 3.35).

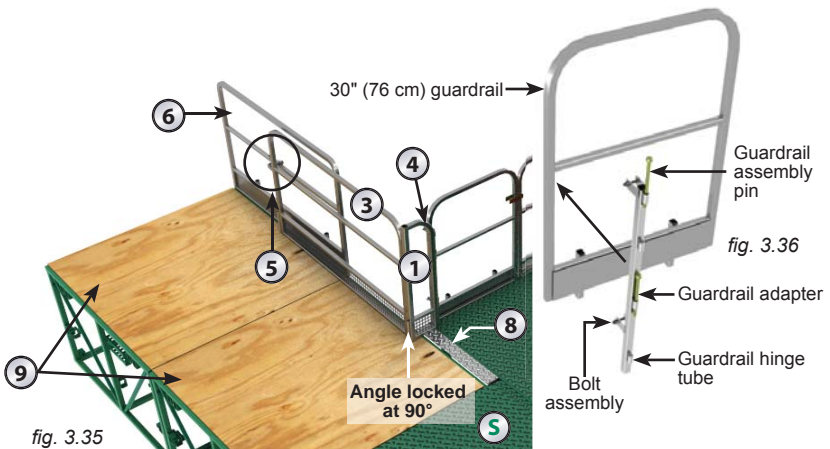

Back 90° cantilever configuration

- 9- Make sure all the necessary guardrails are in place and secure (see the *Accessories* section on p. 94 for more information about guardrails). In all cases where workers are exposed to fall hazards greater than specified by local regulations, the installation of guardrails or face guardrail supports is **mandatory**.

**WARNING**

It is important to verify and make sure to remove any gap there may be on the platform. Cover gaps by adjusting guardrails or by using plywood, planking or any other strong material. Secure the material in such a way that it remains in place and does not impede safe circulation on the deck. It is also important to make sure that all guardrails are properly secured.

Bridges

Swivel Bridge

Bearing Bridge Configurations

Front bearing configurations – 0° to 45° angle

- 1- Make sure that the adjustment rod is installed on the appropriate side of the bridge to achieve the desired configuration. If required, remove the bolt assemblies at both ends of the adjustment rod and reinstall it on the other side of the bridge (fig. 3.19, p. 47).
- 2- Lock the angle pivot between parts “A” and “B” of the swivel bridge guardrail assembly at 0° using the angle stopper (fig. 3.37).
- 3- Align the plates of the guardrail adapter (fig. 3.33, p. 49) with the **side** of the 28" (71 cm) guardrail on the main frame of the unit and secure in place with bolts.
- 4- Align the tubes on the swivel bridge guardrail assembly with the tubes on the adapter on the 28" (71 cm) guardrail and secure in place with guardrail pins (fig. 3.33, p. 49).
- 5- Install the twin mast adapter guardrail on the twin mast adapter.
- 6- Slide part “C” of the swivel bridge guardrail behind the assembly of parts “A” and “B”, as shown in fig. 3.37, and secure one end to the assembly of parts “A” and “B” using the sliding bracket (fig. 3.37).

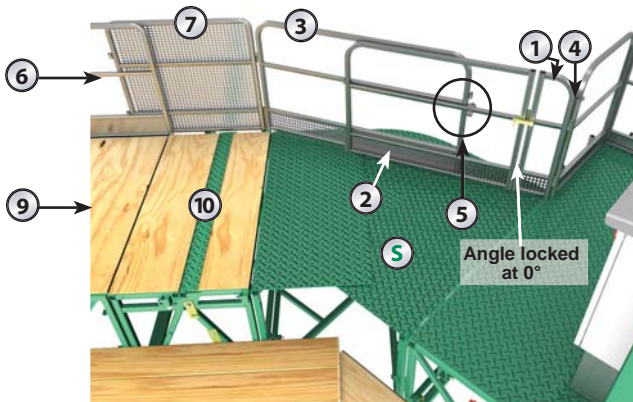

fig. 3.37 Front 45° bearing configuration

- 7- Using guardrail assembly pins, secure the other end of part “C” of the swivel bridge guardrail assembly to the twin mast adapter guardrail (fig. 3.37).
- 8- Make sure all the necessary guardrails are in place and secure (see the *Accessories* section on p. 94 for more information about guardrails). In all cases where workers are exposed to fall hazards greater than specified by local regulations, the installation of guardrails or face guardrail supports is **mandatory**.

LEGEND			
① Part “A” of swivel bridge guardrail assembly	④ Guardrail adapter	⑦ Twin mast adapter guardrail	⑩ Twin mast adapter guardrail
② Part “B” of swivel bridge guardrail assembly	⑤ Sliding bracket to secure guardrails together	⑧ Gap filler	Ⓢ Swivel bridge
③ Part “C” of swivel bridge guardrail assembly	⑥ Standard 60”(1,5 m) guardrail	⑨ 5’ (1,5 m) bridge	

Bridges

Swivel Bridge

Bearing Bridge Configurations

Front bearing configuration – 90° angle

- 1- Make sure that the adjustment rod is installed on the appropriate side of the bridge to achieve the desired configuration. If required, remove the bolt assemblies at both ends of the adjustment rod and reinstall it on the other side of the bridge (fig. 3.19, p. 47).
- 2- Part “A” of the swivel bridge guardrail assembly is not required for 90° front bearing configurations. Separate all three parts (“A”, “B” and “C”) of the swivel bridge guardrail assembly, if necessary.
- 3- Align the plates of the guardrail adapter (fig. 3.33, p. 49) with the **side** of the 28" (71 cm) guardrail on the main frame of the unit and secure in place with bolts.
- 4- Install part “B” of the swivel bridge guardrail assembly **backwards** (as shown in fig. 3.38) and align its tubes with the tubes on the adapter on the 28" (71 cm) guardrail on the main frame of the unit. Secure in place with guardrail pins (fig. 3.33)
- 5- Insert the guardrail assembly pins on part “C” in the corresponding tubes on part “B”. Secure the assembly with cotter pins.
- 6- Install the twin mast adapter guardrail on the twin mast adapter.

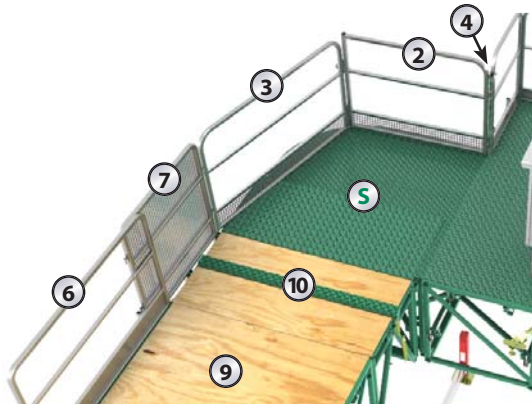

Front 90° bearing configuration *fig. 3.38*

- 7- Secure part “C” of the swivel bridge guardrail assembly to the twin mast adapter guardrail.
- 8- Make sure all the necessary guardrails are in place and secure (see the *Accessories* section on p. 94 for more information about guardrails). In all cases where workers are exposed to fall hazards greater than specified by local regulations, the installation of guardrails or face guardrail supports is **mandatory**.



WARNING

Swivel bridge guardrails must not be used to tie a lifeline.

Bridges

Swivel Bridge

Bearing Bridge Configurations

Back bearing configurations – 0 to 45° angle

- 1- Make sure that the adjustment rod is installed on the appropriate side of the bridge to achieve the desired configuration. If required, remove the bolt assemblies at both ends of the adjustment rod and reinstall it on the other side of the bridge (fig. 3.19, p. 47).
- 2- Part “C” of the swivel bridge guardrail assembly is not required for 0 to 45° back bearing configurations. Lock the angle pivot between parts “A” and “B” of the swivel bridge guardrail assembly at 90° using the angle stopper (fig. 3.39).
- 3- Align the plates of the guardrail adapter (fig. 3.33, p. 49) with the **side** of the 28" (71 cm) guardrail on the main frame of the unit and secure in place with bolts.
- 4- Align the tubes on the swivel bridge guardrail assembly with the tubes on the adapter on the 28" (71 cm) guardrail and secure in place with guardrail pins (fig. 3.33, p. 49).
- 5- Install the twin mast adapter guardrail on the twin mast adapter.
- 6- Verify and make sure to remove any gap there may be on the platform.
- 7- Make sure all the necessary guardrails are in place and secure (see the *Accessories* section on p. 94 for more information about guardrails). In all cases where workers are exposed to fall hazards greater than specified by local regulations, the installation of guardrails or face guardrail supports is **mandatory**.

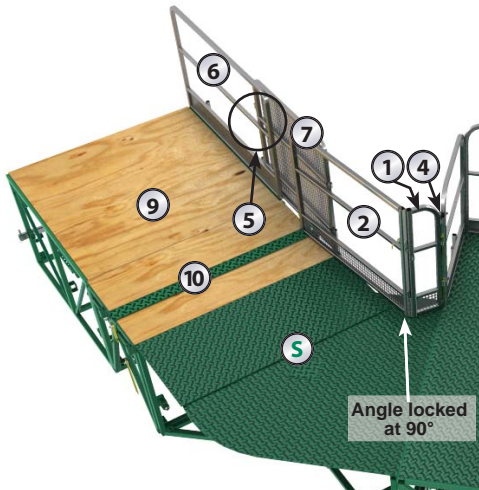

fig. 3.39 Back 45° bearing configuration

**WARNING**

It is important to verify and make sure to remove any gap there may be on the platform. Cover gaps by adjusting guardrails or by using plywood, planking or any other strong material. Secure the material in such a way that it remains in place and does not impede safe circulation on the deck. It is also important to make sure that all guardrails are properly secured.

Bridges

Swivel Bridge

Bearing Bridge Configurations

Back bearing configuration – 90° angle

- 1- Make sure that the adjustment rod is installed on the appropriate side of the bridge to achieve the desired configuration. If required, remove the bolt assemblies at both ends of the adjustment rod and reinstall it on the other side of the bridge (fig. 3.19, p. 47).
- 2- Part “B” of the swivel bridge guardrail assembly is not required for 90° back bearing configurations. Separate all three parts (“A”, “B” and “C”) of the swivel bridge guardrail assembly, if necessary.
- 3- Assemble part “A” and “C” of the swivel bridge guardrail assembly.
- 4- Align the plates of the guardrail adapter (fig. 3.36, p. 51) with the **front** of the 30" (76 cm) guardrail on the main frame of the unit and secure in place with bolts.
- 5- Align the tubes on the swivel bridge guardrail assembly with the tubes on the adapter on the 30" (76 cm) guardrail and secure in place with guardrail pins (fig. 3.36, p. 51).
- 6- Install the gap filler (fig. 3.40) to fill the gap on the platform.
- 7- Install a 60" (1,5 m) regular guardrail on the bridge attached to the swivel bridge.

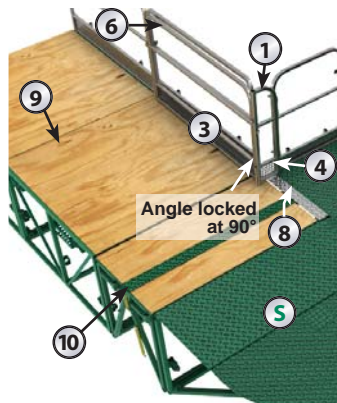

fig. 3.40 Back 90° bearing configuration

- 8- Secure part “C” of the swivel bridge guardrail assembly to the 60" (1,5 m) guardrail by tightening the bolt on the sliding bracket (fig. 3.40).
- 9- Make sure all the necessary guardrails are in place and secure (see the *Accessories* section on p. 94 for more information about guardrails). In all cases where workers are exposed to fall hazards greater than specified by local regulations, the installation of guardrails or face guardrail supports is **mandatory**.

LEGEND

- | | | | |
|--|---|-------------------------------|---------------------|
| ① Part “A” of swivel bridge guardrail assembly | ④ Guardrail adapter | ⑦ Twin mast adapter guardrail | ⑩ Twin mast adapter |
| ② Part “B” of swivel bridge guardrail assembly | ⑤ Sliding bracket to secure guardrails together | ⑧ Gap filler | ⑤ Swivel bridge |
| ③ Part “C” of swivel bridge guardrail assembly | ⑥ Standard 60"(1,5 m) guardrail | ⑨ 5' (1,5 m) bridge | |

Bridges

Swivel Bridge Counterweight Adapter
(optional)

The optional counterweight and adapter for the installation of a counterweight bridge are designed to be used in a swivel bridge 90° front cantilever configuration to increase the capacity of the forward cantilever bridges used in the setup. The counterweight adapter is required to attach a counterweight bridge to the swivel bridge. The use of a counterweight for any other swivel bridge configuration is not advantageous and should not be considered.

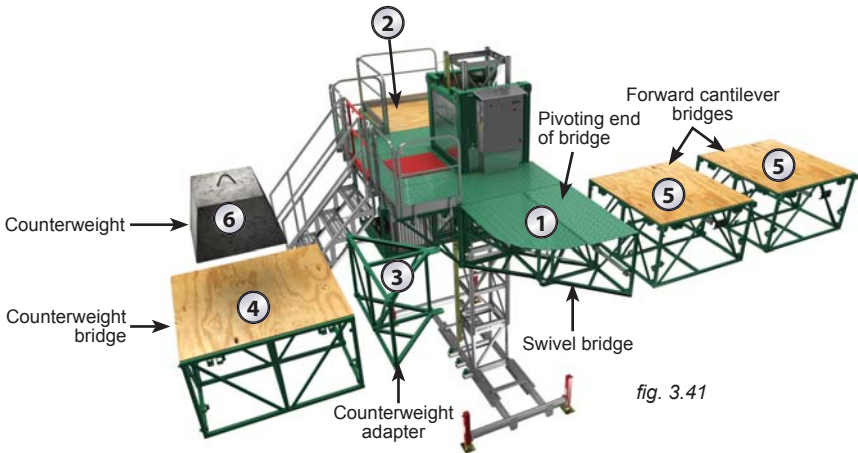

fig. 3.41

Recommended order of installation:

- 1 Swivel bridge
- 2 Cantilever bridge on opposite side of mast
- 3 Counterweight adapter
- 4 Counterweight bridge
- 5 Forward cantilever bridges (as required and allowed)
- 6 Apply counterweight

Installation

- 1- Make sure that there are no bridges installed except for the swivel bridge and the cantilever bridge on the other side of the mast.
- 2- Make sure that the end of the swivel bridge that is not bolted to the main frame (pivoting end, fig. 3.41) is supported so the two halves of the swivel bridge remain together.
- 3- Remove the lock bolt from the top pivot pin (fig. 3.43, p. 57). It is not necessary to remove the lock bolt from the bottom pivot pin.
- 4- Lift out the top pivot pin until it clears the top part of the pivot structure (fig. 3.43, p. 57) and it is possible to align the hole in the top plate of the counterweight adapter. It is not necessary to remove the pivot pin completely. Lift out the bottom pivot pin until it is possible to insert the bottom plate (forked) of the counterweight adapter around the pivot pin.

Bridges

Swivel Bridge Counterweight Adapter
(optional)

Installation (cont'd)

- 5- Slide in the bottom plate of the counterweight adapter around the bottom pivot pin and align the hole of the top plate with the top pivot pin. Replace the top pivot pin.
- 6- Replace the lock bolt of the top pivot pin and tighten to secure.
- 7- Secure the counterweight adapter to the frame of the swivel bridge with bolt assemblies to lock it into position (fig. 3.46).

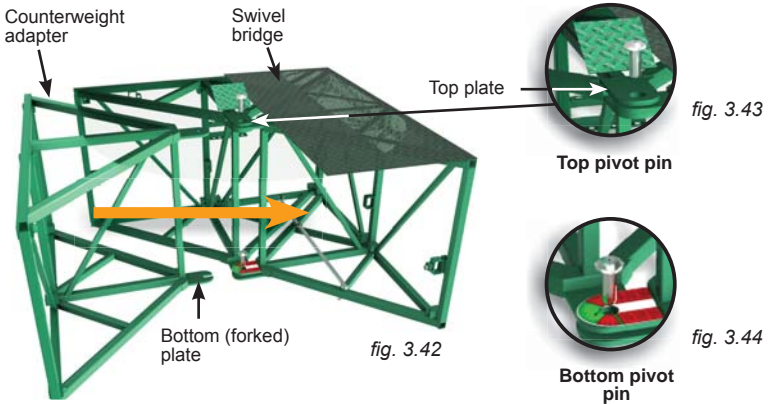

- 8- Bolt a standard 5' (1,5 m) bridge to the counterweight adapter as described in steps 1 and 2 of the installation instructions for a standard bridge, on p. 41 of the *Bridges* section.

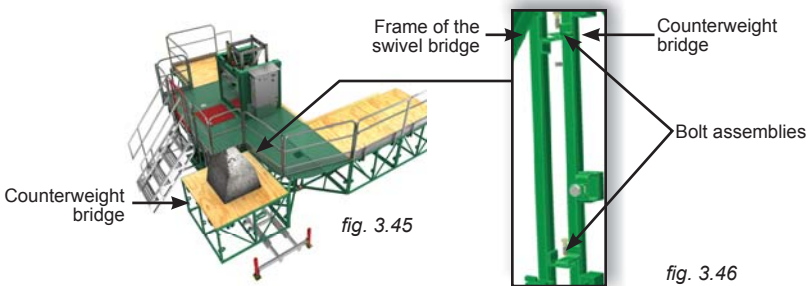

- 9- Install forward cantilever bridges, as required and allowed (fig. 3.41, p. 56). Refer to the *Load Capacities* section on p. 84 for the number of bridges allowed in a configuration.
- 10- Apply the counterweight on the installed bridge. For information on the type of counterweight to apply, refer to p. 90 of the *Load Capacities* section.

Bridges

Swivel Bridge Outrigger Support Assembly (optional)

The outrigger support assembly is designed to be used as a plank support structure in swivel bridge back configurations (0 to 45° and 90°).

0 to 45° configurations



fig. 3.47



fig. 3.48



Outrigger support assembly

90° configuration



fig. 3.49



fig. 3.50

Outrigger support assembly stored inside swivel bridge (transport position)

Installation

- 1- Make sure that the end of the swivel bridge that is not bolted to the main frame (pivoting end, fig. 3.41, p. 56) is supported so the two halves of the swivel bridge remain together.
- 2- Remove the lock bolt from the top pivot pin (fig. 3.52). It is not necessary to remove the lock bolt from the bottom pivot pin.
- 3- Lift out the top pivot pin until it clears the top part of the pivot structure (fig. 3.52) and it is possible to align the hole in the top plate of the outrigger support assembly. It is not necessary to remove the pivot pin completely. Lift out the bottom pivot pin until it is possible to insert the bottom plate around the pivot pin of the outrigger support assembly.
- 4- Slide in the bottom plate of the outrigger support assembly around the bottom pivot pin and align the hole of the top plate with the top pivot pin. Insert the pivot pin.
- 5- Tighten the top lock bolt to secure the top pivot pin.

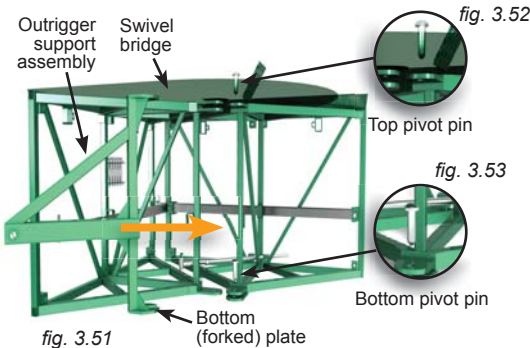

fig. 3.51



Top pivot pin



Bottom pivot pin



fig. 3.54

Bridges

Swivel Bridge Outrigger Support Assembly
(optional)

Installation (cont'd)

- 6- Slide two 84" (2,1 m) outriggers in the outrigger support and secure them in place with bolt assemblies (fig. 3.55). Slide two swivel cross boxes on the outriggers installed in this step.
- 7- Install 63" (1,6 m) outriggers where required, according to the planking configuration. It may be required to cut the outriggers installed close to the outrigger support assembly to an appropriate size (fig. 3.55). Slide a standard cross box on each of the outriggers installed in this step.

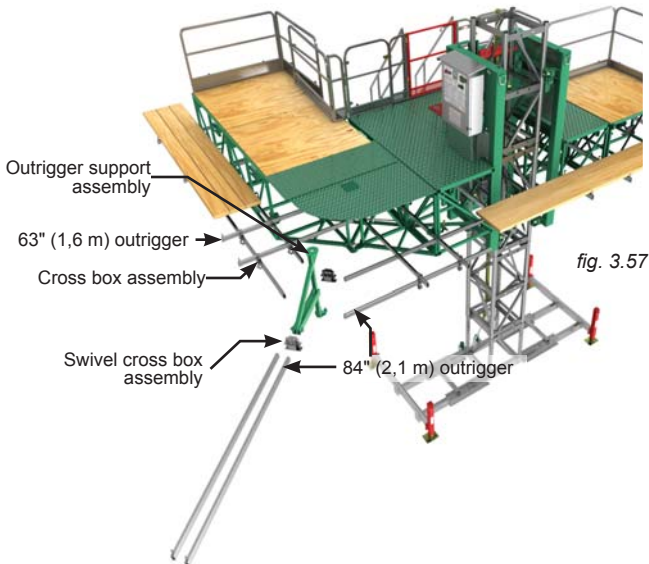
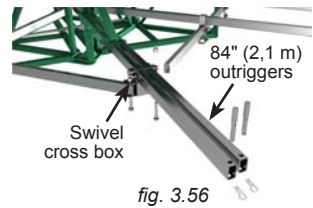

- 8- Slide 84" (2,1 m) cross outriggers in the standard cross boxes installed in step 7 (fig. 3.55). These outriggers must be perpendicular to the 63" (1,6 m) outriggers.
- 9- Complete the outrigger installation by sliding 84" (2,1 m) outriggers in the swivel cross boxes installed in step 6 (fig. 3.56).
- 10- Tighten the bolt assemblies on all cross boxes and make sure all the outriggers are secure.

Power Pack and Operating Components

General Guidelines

In order to avoid overheating the electric motors and affect their life expectancy, it is very important to respect the proper operating duty cycle of the mast climbing work platform. The duty cycle of a mast climbing work platform is rated as minutes of operation in an hour; the remainder of the hour is allocated to the cooling of the motors.

The operation duty cycle for the S Series motorized unit in a mast climbing work platform application is as shown in fig. 4.1.

fig. 4.1

Duty Cycle – Mast Climbing Work Platform Application					
% of maximum capacity	Amperage ¹	Service factor	Duty cycle allowed ²	Maximum operation time / hour ²	Minimum cooling time / hour ²
65	39.35 A	1	100%	60 min	0 min
75	41.25 A	1.05	83%	50 min	10 min
90	44.1 A	1.12	42%	25 min	35 min
100	46 A	1.2	25%	15 min	45 min

¹ For 240V units only; for 400V units, contact the Hydro Mobile technical support team
² Based on a maximum outside temperature of 104°F (40°C)



WARNING

The duty cycles listed in fig. 4.1 do not apply to an S Series motorized unit used in a transport platform application.

- 1- Make sure that the motorized unit has been installed following the installation guidelines described in the *Motorized Unit* section, on p. 16 and that it can be operated safely.
- 2- Select a power cable that is suitable for the height of the mast. Hook up the power cable to the motorized unit. **This installation must be performed by a certified electrician.** Refer to the *Power Cable Selection* chart (fig. 4.2) to select the appropriate power cable for the installation. Contact the Hydro Mobile technical support if a cable longer than 800' (244 m) is required.
- 3- Install the power cable as described in the installation instructions on p. 61 of this section.

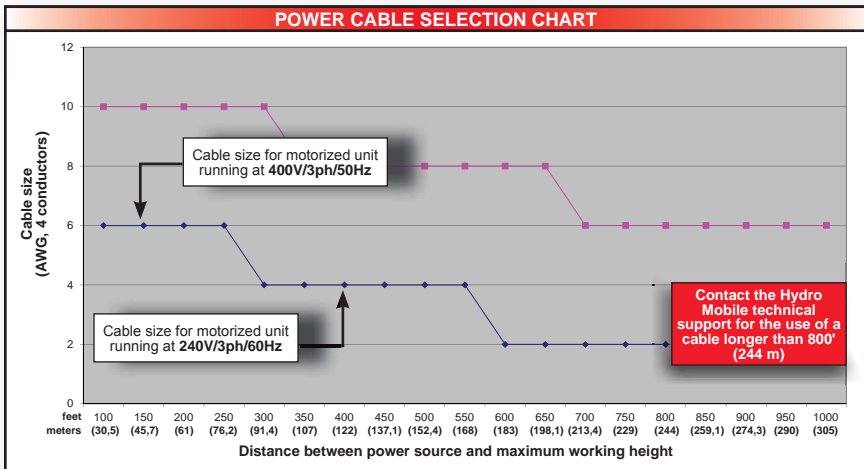

fig. 4.2

Power Pack and Operating Components

Installation of the Power Cable

Masts with a height of 150' (45,7 m) or less

- 1- Select the appropriate power cable for the height of the mast. Refer to the *Power Cable Selection Chart* (fig. 4.2, p. 60) for help with the selection of the power cable. Make sure that the overall length of the cable is sufficient for the installation (height of mast, distance from power source, acceptable overall slack in cable).
- 2- Run the power cable through to the first bridge of the setup. The cable must clear the base completely.

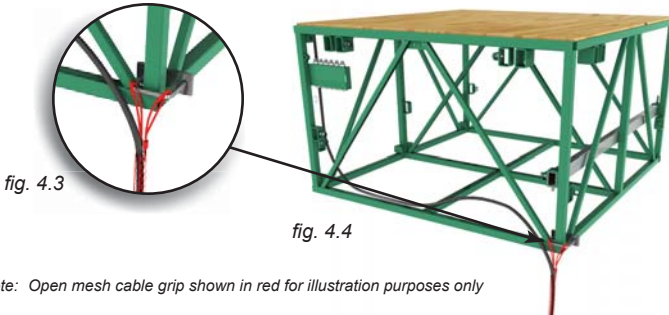

Note: Open mesh cable grip shown in red for illustration purposes only

- 3- Retrieve the open mesh grip kit from the toolbox (fig. 4.3). Using the U bolt and flat bar assembly, attach the open mesh grip at the bottom of a vertical tube on the bridge (fig. 4.4). Run the cable through the wire mesh grip.
- 4- Hook up the power cable to the control panel and to an appropriate power source. **This installation must be performed by a certified electrician.**

Masts with a height over 150' (45,7 m)

An S Series motorized unit must not be used on a mast with a height over 500' (152 m). On a mast with a height over 150' (45,7 m), the use of the **optional cable trolley kit** is strongly recommended.

- 1- Select the appropriate power cable for the height of the mast. Refer to the *Power Cable Selection Chart* (fig. 4.2, p. 60) for help with the selection of the power cable. Make sure that the overall length of the cable is sufficient for the installation (height of mast, distance from power source, acceptable overall slack in cable).
- 2- Install the optional cable trolley kit as described in the installation instructions on p. 109 of the *Accessories* section.
- 3- Hook up the power cable to the control panel and to an appropriate power source. **This installation must be performed by a certified electrician.**



WARNING

Installation of the power cable must be performed by a **certified electrician**.

Power Pack and Operating Components

Motorized unit startup procedure

- 1- Prepare the motorized unit by following the general guidelines, on p. 60.
- 2- Connect the power cable to a safe and reliable power source (from the building or a generator). **This installation must be performed by a certified electrician.** Make sure that the input voltage is within the specified range. Refer to p. 11 of the *Motorized Unit* section for more information on the input power range.
- 3- Turn on the main disconnect switch.
- 4- Pull out the emergency stop button (fig. 5.1, p. 63) to power on the display panel. If the display panel does not turn on after a short period of time, make sure that the power cable is properly connected to both the power source and to the motorized unit. If the cable is connected, verify the phase selector and make sure the appropriate phase has been selected. The phase selector should be at the left (1) or right (2) position. The middle (0) position is neutral and will prevent the unit and panel from powering on. If the display panel still does not turn on, push in the emergency stop button, turn off the main disconnect switch and contact a certified electrician.
- 5- Once powered on, unlock the display panel as described in the instructions on p. 64 of the *Control Panel* section.
- 6- If the motorized unit is used in a multiple unit configuration, make sure that the inclinometer has been connected to the proper port into the control panel and that the inclinometer option has been enabled on the display panel. If required, install an optional communication cable and enable the communication cable on the display panel. Make sure that the feedback cable has been installed and is working properly. Refer to the *Safety Devices* section on p. 37 for information about the inclinometer and on p. 35 for information about the feedback cable. For instructions on enabling options on the display panel, refer to p. 72 of the *Control Panel* section.

Motorized unit shutdown procedure

- 1- If the motorized unit was used in a multiple unit configuration, make sure that no slope alert is displayed on the display panel and that the structure is level.
- 2- Bring the motorized unit down to base level.
- 3- In order to avoid unauthorized operation of the motorized unit, perform the following steps to lock the control panel:
 - a. Return to the main menu on the display screen
 - b. Press **twice** on the OK button under the display screen to reach the access code entry screen
 - c. Press on one of the bottom left buttons to log out of the panel
- 4- Push in the emergency stop button to shut down the control panel.
- 5- Turn off the main disconnect switch.
- 6- Before transporting or storing the unit for any significant length of time, refer to instructions on p. 112 of the *Transport, Storage and Maintenance* section.



Auxiliary power outlets are disabled when the motorized unit is moving.

Control Panel

The control panel is the brain behind the Hydro Mobile S Series system. The control panel is a combination of manual controls and a color non touch screen. Driven by a computer system programmed to detect and analyze every signal and react accordingly, the display panel will notify the operator of any important event and display appropriate instructions to respond to the alert (see figures below as well as descriptions and instructions included in the *Screen Alerts and Instructions* in the following pages). Instructions and descriptions on the control panel are displayed in three operating languages (English, French and Spanish). Screen displays and instructions are in English, French and Spanish.

It is mandatory to comply with the instructions included in the following pages for the operation of the control panel and to take prompt corrective action when required. For any event other than those described in this manual, contact the distributor/service center or the Hydro Mobile technical support team.

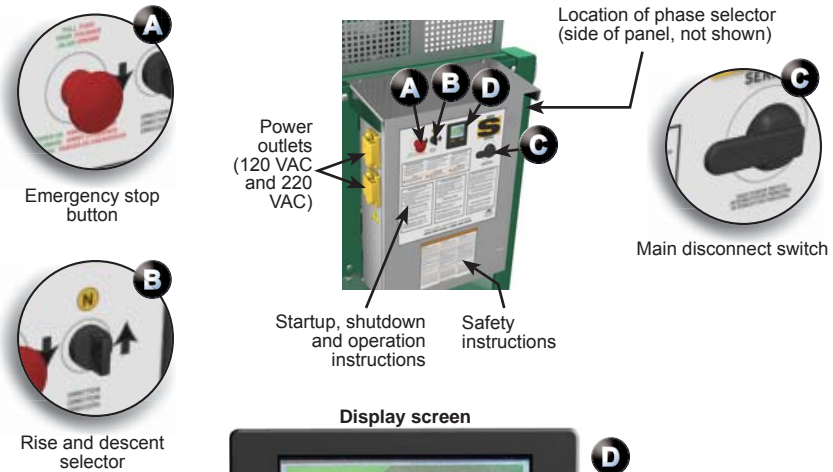

fig. 5.1

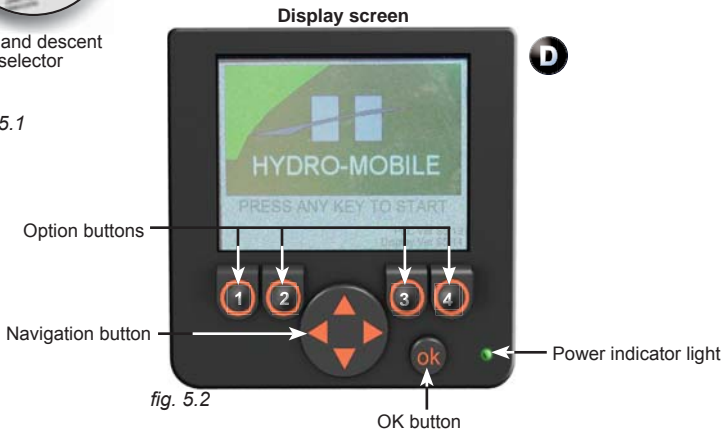

fig. 5.2

Note: Numbers on the above option buttons are displayed as an example only. Actual messages displayed may differ from picture.



If the display panel does not turn on after a short period of time, make sure that the power cable is properly connected both to the power source and to the motorized unit and that the appropriate phase has been selected. If the display panel still does not turn on, turn off the main disconnect switch and contact a certified electrician.

Control Panel

Control panel controls		
Control	Description	Action
Rise and descent selector	Controls the travel direction of the unit.	Turn and hold the selector to the right to raise the platform. Turn and hold the selector to the left to lower the platform.
Emergency stop button	Shuts down the power to the control panel in the course of normal operation or in case of an emergency.	In the course of normal operation , push in the emergency stop button to shut down the power to the control panel when the unit is not in use. In case of emergency , push in the emergency stop button to shut down the power to the control panel.
Main disconnect switch	Turns the main power on or off.	Turn the handle down to power on (clockwise). Turn the handle up to power off (counterclockwise).
Phase selector	Selection of the phase.	Turn the selector to the left (1) or right (2) position. Middle (0) position is neutral; the unit and panel cannot be powered on.
Control screen	Non touch screen (with options and navigation buttons) displaying alerts and instructions.	Refer to information included in the following pages to appropriately understand each of the messages displayed on the screen.

Screen alerts and instructions

fig. 5.3

Unlocking the display screen

- 1- Turn on the main disconnect switch. Pull out the emergency stop button.
- 2- If the display panel does not turn on after a short period of time, make sure that the power cable is properly connected to both the power source and to the motorized unit. If the cable is connected, verify the phase selector and make sure the appropriate phase has been selected. The phase selector (fig. 5.1, p. 63) should be at the left (1) or right (2) position. The middle (0) position is neutral and will prevent the unit and panel from powering on. If the display panel still does not turn on, turn off the main disconnect switch and contact a certified electrician.
- 3- Once the panel is powered on, press on any key under the display screen to activate it.
- 4- Once on the access code entry page, it is possible to change the display language by pressing the rightmost button (button 4 on the illustration below).

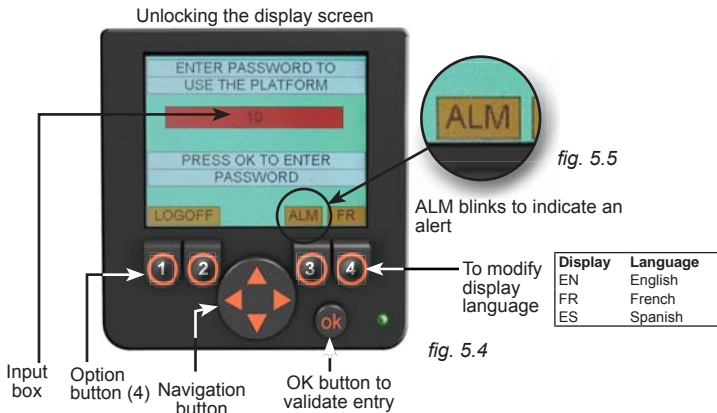

fig. 5.5

fig. 5.4

Note: Numbers on the above option buttons are displayed as an example only.

Control Panel

Screen alerts and instructions

- 5- If an event is detected by the panel, the ALM rectangle will blink (above button 3 in fig. 5.4, p. 64) to indicate it. The display screen must be unlocked to display the alert info screen.
- 6- To enter the operating access code (default "10"), press on the OK button. Once the input box is blinking, use the UP and DOWN arrows (on the navigation button) to change the value, then press OK to unlock the display screen. The default operating access code can be changed by the qualified erector/dismantler or the qualified technician.
- 7- Once unlocked, the screen displays the main menu page. Press on the appropriate option button to go to the selected option.

Main menu screen



fig. 5.6

Screen	Description	Access level
F1 – Status info	Information on the status of the unit and its components (door sensors, inclinometer, total runtime hours, etc.)	Operator
F2 – Alarms	Information on any event detected by the control panel that could prevent the unit and its components to operate safely	Operator
F3 – Inputs and outputs	Status of various controls, sensors and switches linked to input and output ports	Operator
F4 – Configuration	Screens allowing the modification of certain options for the unit or the installation (enabling door sensors, enabling inclinometers, modifying user-level password, resetting maintenance runtime counter, etc.)	Erector/ Dismantler (level 1)
Pressing twice on OK button	Entry-level access page to log out and lock panel	Operator

fig. 5.7

F1 – Status info

Access level: Operator

This two-page section displays general information about the unit and the installation.

- 1- Press F1 on the main menu screen (button 1 on the main menu screen display example in fig. 5.6).
- 2- Change display pages with the option buttons (buttons 1 and 2 in fig. 5.8, p. 66).
- 3- Press the BACK button (button 4 in fig. 5.8, p. 66) to return to the main menu page.

Control Panel

Screen alerts and instructions



Screen 1 of Status Info *fig. 5.8*



fig. 5.9 Screen 2 of Status Info

Note: Numbers on the above option buttons are displayed as an example only.

F2 – Alerts

Access level: Operator

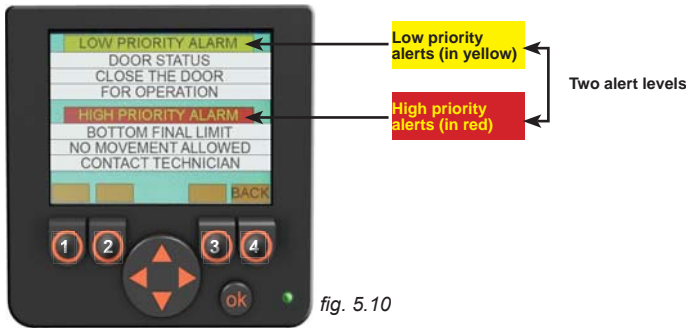

fig. 5.10

Note: Numbers on the above option buttons are displayed as an example only. Actual messages displayed may differ from picture.

This section displays events detected by the control panel that could compromise the safe operation of the unit and its components. Display of the various alerts will alternate automatically if more than one page is required.

Once an event is detected, the ALM rectangle (fig. 5.9) will blink to signal an alert. This section may also be reached at all times by pressing on the ALM button (button 3 in fig. 5.8). Press the BACK button (button 4 in the example in fig. 5.10) to return to the main menu screen.

Control Panel

F2 – Alerts

MINOR ALERTS					
Alert	Event	Action	UP travel	DOWN travel	Unit LOCKED
10 FOOT STOP 3 SEC STOP TO VERIFY ALL CLEAR UNDER PLATFORM	Going DOWN, unit stops for 3 seconds	Make sure there are no interferences under the platform Used in transport platform configurations	NOT ALLOWED	NOT ALLOWED	NO
BOTTOM LIMIT UPWARD TRAVEL ONLY	Going DOWN, unit stops	Bottom limit reached; only upward travel allowed	ALLOWED	NOT ALLOWED	NO
COMMUNICATION ERROR	Unit stops	Make sure remote panel is online; make sure communication option is activated on remote control panel; make sure communication cable is connected properly; make sure communication option is disabled for a single unit installation	NOT ALLOWED	NOT ALLOWED	NO
DOOR STATUS	Unit stops	Check all doors on the installation and make sure they are closed properly	NOT ALLOWED	NOT ALLOWED	NO
INCL L > 2DEG POS GO UP OR DOWN TO LEVEL	Going UP, unit keeps moving Going DOWN, unit stops	No action required; motion of unit is adjusted automatically	ALLOWED	NOT ALLOWED	NO
INCL L > 2DEG NEG GO UP OR DOWN TO LEVEL	Going UP, unit stops Going DOWN, unit keeps moving	No action required; motion of unit is adjusted automatically	NOT ALLOWED	ALLOWED	NO
INCL R > 2DEG POS GO UP OR DOWN TO LEVEL	Going UP, unit keeps moving Going DOWN, unit stops	No action required; motion of unit is adjusted automatically	ALLOWED	NOT ALLOWED	NO
INCL R > 2DEG NEG GO UP OR DOWN TO LEVEL	Going UP, unit stops Going DOWN, unit keeps moving	No action required; motion of unit is adjusted automatically	NOT ALLOWED	ALLOWED	NO
REMOTE PANEL ALARM SEE REMOTE PANEL REMOTE PANEL OFFLINE	Unit stops when communication is used	Make sure remote panel is online or see local alarm on remote panel	NOT ALLOWED	NOT ALLOWED	NO
REMOTE PANEL LOCK ENTER PASSWORD	Unit stops	See remote panel	NOT ALLOWED	NOT ALLOWED	NO
TOP LIMIT DOWNWARD TRAVEL ONLY	Going UP, unit stops	Top limit reached; only downward travel allowed	NOT ALLOWED	ALLOWED	NO

fig. 5.11

Control Panel

F2 – Alerts

MAJOR ALERTS						
Alert	Event	Action	UP travel	DOWN travel	Unit LOCKED	
BOTTOM FINAL LIMIT NO MOVEMENT ALLOWED CONTACT TECHNICIAN	Going DOWN, unit stops	Inspect the bottom limit sensor and make sure it is working properly, alarm is related to signal of BFL mechanical limit switch	NOT ALLOWED	NOT ALLOWED	NO	
BOTTOM FINAL LIMIT FAULT CONTACT TECHNICIAN	Unit stops; travel is not allowed	Unit is locked and must be reset by qualified E&D personnel or a qualified technician after inspection	NOT ALLOWED	NOT ALLOWED	YES	
ELEC PHASE DETECTOR CHANGE PHASE SELECTOR CHECK MOTOR OVERLOAD	Travel is not allowed	Perform phase inversion (using phase selector on side of control panel). If problem persists, shut down main power and contact certified electrician	NOT ALLOWED	NOT ALLOWED	NO	
INCL L > 5DEG POS GO UP OR DOWN TO LEVEL	Unit stops	Inclinometer value is out of range; make sure the inclinometer is plugged in and is into the appropriate port (LEFT); verify the level adjustment for the inclinometer; make sure the inclinometer option is disabled for a single unit installation	NOT ALLOWED	NOT ALLOWED	NO	
INCL L > 5DEG NEG GO UP OR DOWN TO LEVEL	Unit stops	Inclinometer value is out of range; make sure the inclinometer is plugged in and is into the appropriate port (LEFT); verify the level adjustment for the inclinometer; make sure the inclinometer option is disabled for a single unit installation	NOT ALLOWED	NOT ALLOWED	NO	
INCL R > 5DEG POS GO UP OR DOWN TO LEVEL	Unit stops	Inclinometer value is out of range; make sure the inclinometer is plugged in and is into the appropriate port (RIGHT); verify the level adjustment for the inclinometer; make sure the inclinometer option is disabled for a single unit installation	NOT ALLOWED	NOT ALLOWED	NO	
INCL R > 5DEG NEG GO UP OR DOWN TO LEVEL	Unit stops	Inclinometer value is out of range; make sure the inclinometer is plugged in and is into the appropriate port (RIGHT); verify the level adjustment for the inclinometer; make sure the inclinometer option is disabled for a single unit installation	NOT ALLOWED	NOT ALLOWED	NO	

fig. 5.12

Control Panel

F2 – Alerts

MAJOR ALERTS						
Alert	Event	Action	UP travel	DOWN travel	Unit LOCKED	
INPUT POWER FAULT RETURN TO BASE LEVEL ONLY	DOWNWARD travel only	Input voltage too low while unit is moving; return to base level; contact certified electrician and check input power	NOT ALLOWED	ALLOWED	NO	
OVER AMPERAGE DOWN CHECK POWER SOURCE OR LOAD	Going DOWN; unit stops	Amperage draw is too high while moving DOWN; check load on platform as per configuration; check for mechanical obstruction	ALLOWED	NOT ALLOWED	NO	
OVER AMPERAGE UP CHECK POWER SOURCE OR LOAD	Going UP; unit stops	Amperage draw is too high while moving UP; check load on platform as per configuration; check for mechanical obstruction	NOT ALLOWED	ALLOWED	NO	
OVER VOLTAGE (STAT) CHECK POWER SOURCE	Travel is not allowed	Input voltage too high; contact certified electrician and check input power	NOT ALLOWED	NOT ALLOWED	NO	
TOP FINAL LIMIT DOWNWARD TRAVEL ONLY CONTACT TECHNICIAN	Going up; unit stops; only DOWNWARD travel is allowed	Inspect the top limit sensor and make sure it is working properly; alarm is related to signal of TFL mechanical limit switch; only downward travel is allowed	NOT ALLOWED	ALLOWED	NO	
TOP FINAL LIMIT FAULT RETURN TO BASE LEVEL ONLY CONTACT TECHNICIAN	DOWNWARD travel only	Downward travel is allowed until bottom limit (BL) is reached; unit then locks up and must be reset by qualified E&D personnel or a qualified technician after inspection	NOT ALLOWED	ALLOWED	NO	
TOP FINAL LIMIT FAULT UNIT LOCKED CONTACT TECHNICIAN	Unit is locked; travel is not allowed	Unit is locked and must be reset by qualified E&D personnel or a qualified technician after inspection	NOT ALLOWED	NOT ALLOWED	YES	
UNDER VOLTAGE (STAT) CHECK POWER SOURCE	Travel is not allowed	Input voltage too low; contact certified electrician and check input power	NOT ALLOWED	NOT ALLOWED	NO	

fig. 5.13

Control Panel

F2 – Alerts

Quick Reference Table – Minor Alerts





































MINOR ALERTS			
			
10 FOOT STOP 3 SEC STOP TO VERIFY ALL CLEAR UNDER PLATFORM			
BOTTOM LIMIT UPWARD TRAVEL ONLY			
COMMUNICATION ERROR			
DOOR STATUS			
INCL L > 2DEG POS GO UP OR DOWN TO LEVEL			
INCL L > 2DEG NEG GO UP OR DOWN TO LEVEL			
INCL R > 2DEG POS GO UP OR DOWN TO LEVEL			
INCL R > 2DEG NEG GO UP OR DOWN TO LEVEL			
REMOTE PANEL ALARM SEE REMOTE PANEL REMOTE PANEL OFFLINE			
REMOTE PANEL LOCK ENTER PASSWORD			
TOP LIMIT DOWNWARD TRAVEL ONLY			

fig. 5.15









LEGEND	
ICON	DEFINITION
 OR 	Alert (yellow for minor, red for major)
	UPWARD travel is allowed
	DOWNWARD travel is allowed
	Not allowed
	Unit is locked
	Qualified personnel
	Certified electrician
	Qualified E&D personnel or qualified technician

fig. 5.14

Control Panel

Screen alerts and instructions

F3 – Inputs and outputs

Access level: Operator

This section displays information about the various controls, sensors and switches linked to the input and output ports of the control panel. A black circle will indicate that the control panel receives a signal from a sensor or sends a signal to an actuator. Other information will be displayed in values. These pages are mainly useful for troubleshooting operations to provide information on the condition of the unit and the setup to a remote qualified technician.



fig. 5.18



fig. 5.19



fig. 5.20

Note: Numbers on the above option buttons are displayed as an example only.

- 1- Press the F3 button on the main menu page (button 3 in fig. 5.6, p. 65).
- 2- Change display pages with the option buttons (buttons 1 and 2 in fig. 5.18).
- 3- Press the BACK button (button 4 in fig. 5.18) to return to the main menu page.

F4 – Configuration

Access level: Erector / Dismantler

This five-page section includes: one access code entry page for this section (accessible only to the qualified erector/dismantler) and three pages for the modification of setup configuration options, including enabling the inclinometer and resetting the position of the motorized unit when a bottom or top final limit has been triggered. The last page of the section is an access code entry page giving access to options available only to a qualified technician.

- 1- Press the F4 button on the main menu page (button 4 in fig. 5.6, p. 65).
- 2- On the access code entry page, press on the OK button. Once the input box is blinking, use the UP and DOWN arrows (on the navigation button) to change the value (access code available only to the qualified erector/dismantler), then press OK to access the configuration options section pages.
- 3- Change display pages with the option buttons (buttons 1 and 2 in fig. 5.18).
- 4- Use the UP and DOWN arrows on the navigation button to reach the box to be modified.
- 5- Press the OK button to select the box to be modified.
- 6- Once the selected box is blinking, use the UP and DOWN arrows on the navigation button to change the value displayed in the box.
- 7- Press the OK button to confirm the change.
- 8- Press the BACK button (button 4 in fig. 5.22) to return to the main menu page. Access to the configuration options section will automatically be deactivated once the user leaves the section. The access code to access this level will need to be entered again.

Control Panel

Screen alerts and instructions

F4 – Configuration

Access level: Erector / Dismantler

fig. 5.21



fig. 5.22



fig. 5.23



Note: Numbers on the above option buttons are displayed as an example only.

fig. 5.24

Option	Choice	Description
1 DOOR SWITCH1	ENABLE/DISABLE	Option allowing the activation of an additional door switch; this option is linked to the "DOOR SWITCH1" port
2 DOOR SWITCH2	ENABLE/DISABLE	Option allowing the activation of an additional door switch; this option is linked to the "DOOR SWITCH2" port
3 INCLINOMETER L	ENABLE/DISABLE	Option to modify according to setup configuration (single or multiple units); this option must be activated in a multiple-unit configuration; disable option for single unit installation USED WHEN BEARING BRIDGE IS ON LEFT SIDE OF UNIT
4 INCLINOMETER R	ENABLE/DISABLE	Option to modify according to setup configuration (single or multiple units); this option must be activated in a multiple-unit configuration; disable option for single unit installation USED WHEN BEARING BRIDGE IS ON RIGHT SIDE OF UNIT
5 COMMUNICATION	ENABLE L/ENABLE R/ DISABLE	Option allowing communication between two control panels linked by a communication cable in a multiple unit installation; option must be enabled to L or R according to position of unit in the bearing bridge setup; option must be disabled for single unit installation or if no communication cable is not used
6 OPERATOR PWD	VALUE	Option available to erector/dismantler to modify operator (entry level) password
7 PASSWORD	ENABLE/DISABLE	Option to enable or disable the operator password (entry level); when DISABLED, other means must be put in place to prevent unauthorized operation when the operator is not present
8 LEVEL1	VALUE	Option available to qualified E&D personnel to modify Level 1 E&D password
9 RESET RUNTIME	NORMAL/RESET	Option to reset the runtime counter of the unit
10 RESET POSITION	NORMAL/RESET	Option to reset position of motorized unit USED WHEN A BOTTOM OR TOP FINAL LIMIT HAS BEEN TRIGGERED

Mast sections

The installation of mast sections must be performed with care to avoid mishaps that may lead to safety issues. Mast sections loaded on the platform using a crane or a rough terrain forklift **must be distributed equally on either side of the mast to ensure good balance.**

Installation

- 1- Make sure that the motorized unit is positioned properly. Refer to p. 16 of the *Motorized Unit* section for more information.
- 2- Refer to applicable local regulations governing distances between the mast climbing work platform system and electrical lines.
- 3- Remove the mast heads (fig. 6.2).
- 4- Using an optional jib arm (see p. 105 of the *Accessories* section) or any other appropriate lifting device such as a crane or a rough terrain forklift, raise the next mast section and insert it on top of the bottom mast section.
- 5- Make sure that the rack of the mast section is on the rear side (fig. 6.2) and aligned with the rack on the bottom mast section. It is recommended to handle mast sections carefully so as not to damage the mast rack(s).
- 6- Make sure the spring pins on the racks are properly aligned and that the mast sections are connected together (fig. 6.1).
- 7- Using 1"-8 x 8" GR8 bolts and 1" GR8 lock nuts, bolt all four corners together, making sure the bolt heads are facing down. Tighten the four bolt and nut assemblies to 150 lb-ft (203 N-m) of torque to secure the mast section in place.
- 8- Repeat steps 4 through 7 for each mast section.

fig. 6.1

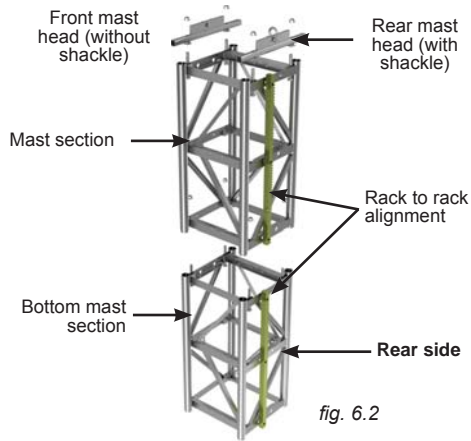
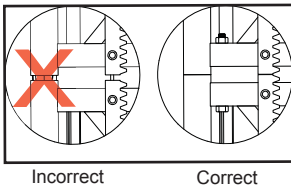

fig. 6.2

- 9- Make sure that the rack is sufficiently greased along the whole length of the mast. **On initial setup and subsequently after every eight hours of cumulative runtime** (with unit traveling up and down the mast), grease must be applied to the rack(s) and gears, from the top of the mast down. For more information, refer to the daily inspection checklist recommended for this motorized unit. **Grease must be allowed to stand for 2-3 hours** before the motorized unit is used again. Use an open gear lubricant recommended by Hydro Mobile. Refer to p. 115 of the *Transport, Storage and Maintenance* section for more information on the appropriate lubrication method.



WARNING

Failure to grease the gears and the mast rack properly and in a timely fashion may cause premature wear of rack and pinion and provoke down time, even lead to serious injury or death.

Mast sections

Installation (cont'd)

- 10- Install the mast heads on the last mast section and keep them in place until the setup is dismantled. If mast heads are not used, make sure that the last mast section has only **one rack** and is installed **backwards**, with the rack facing **toward** the face of the work.

Removal and transport of mast sections

- 1- Remove the mast heads (fig. 6.2, p. 74).
- 2- Remove the bolt assemblies on all four corners.
- 3- Using an optional jib arm (see p. 105 of the *Accessories* section) or any other appropriate lifting device such as a crane or a rough terrain forklift, raise the mast section to be removed.
- 4- Mast sections can be removed and carried in lengths (also referred to as "sticks"). It is recommended to use an optional multiple mast handler to handle pre-assembled lengths of mast sections. For instructions on the use of the optional mast handler, refer to p. 102 of the *Accessories* section.
- 5- If mast sections are to be stored on the platform during erecting and dismantling, make sure they are equally distributed on each side of the mast to ensure good balance. When pre-installing a setup, there must be a **maximum of four mast sections on each side of the mast at a time**. It is recommended to refer to the *Load Capacities* section on p. 84 to avoid overloading the platform.
- 6- Mast sections must be stored on a flat surface away from work areas and construction traffic, vertically or horizontally lying on a side which has no rack.



Mast sections can be pre-assembled in sections to speed up assembly when using a crane. It is recommended to adhere to local regulations for the proper way to lift and handle equipment.

Mast Ties

General guidelines

- 1- Freestanding configurations are not allowed for S Series motorized units unless an optional adapter base for freestanding installation is used. For instructions on the installation and use of an optional adapter base for freestanding installation, refer to p. 103 of the *Accessories* section.
- 2- The pre-installation of mast ties consists in the installation of all mast sections and tie levels necessary to reach the full height of the mast, as required and allowed, **before beginning normal operation of the setup**. The pre-installation of mast ties and tie levels is mandatory for all S Series installations, **except** for single unit **standard** installations. For more information about standard installations, refer to p. 15 of the *Motorized Unit* section.
- 2- An S Series motorized unit must not be used on a mast with a height over 500' (152 m).
- 3- Determine the mast tie components and the quantity required of each according to the installation method appropriate for the installation, the number of planks required and allowed for the configuration and the height of the mast. For more information about methods of installation, see p. 16 of the *Motorized Unit* section.
- 4- Determine the **location of perpendicular mast ties** according to the configuration.

Mast Ties

Installation of standard mast ties

- 1- Align the holes on the mast tie frame with the holes on the mast section. Attach the mast tie frame to the mast section with assemblies of bolts, square washers, lock washers and nuts (4) (fig. 6.5). Tighten all bolt assemblies to a torque of 80 lb-ft (108 N-m).
- 2- Choose the appropriate anchoring system. For more information about wall tie reactions, refer to p. 82 of this section.
- 3- Refer to fig. 6.12, p. 78 for the recommended order of installation of mast ties. Anchor the appropriate wall tie bracket to the building structure.
- 4- If a mast tie extension is required by the configuration, refer to the installation instructions on p. 79 in this section.
- 5- Attach a rigid dual clamp to the vertical tube of the mast tie frame. Make sure that the clamp is tightened to 60 lb-ft (80 N-m) of torque.



fig. 6.3

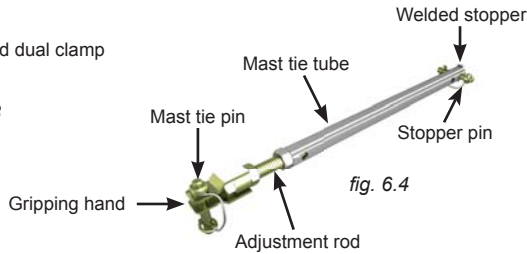

fig. 6.4



WARNING

When using mast ties without welded stoppers, use a bolt or a rigid dual clamp as a stopper at the extremity of the mast tie tube attached to the mast tie frame.

- 6- Attach the mast tie to the rigid dual clamp on the mast tie frame. Tighten the clamp to 60 lb-ft (80 N-m) of torque.
- 7- Install additional rigid dual clamps to secure the mast tie if required. Refer to p. 79 of this section for more information about mast tie extensions and additional rigid dual clamps.
- 8- Adjust the length of the adjustment rod until the mast is plumb on both its front and side axis.
- 9- Repeat steps 5 through 8 for the other two mast ties.

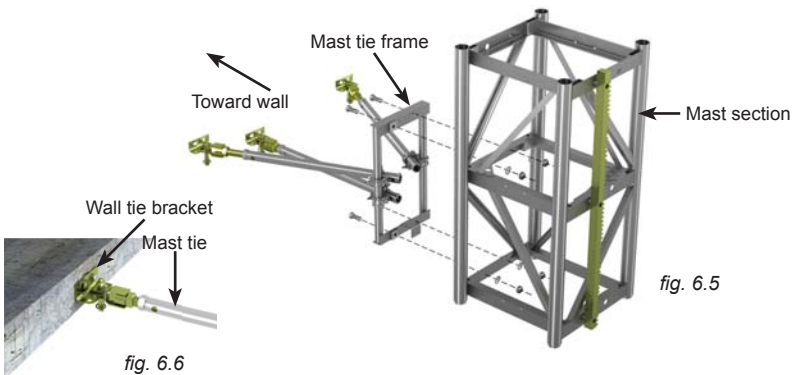

fig. 6.5

fig. 6.6

Mast Ties

fig. 6.7

Methods of Installation				
Type of installation	(A) Single unit	(B) Single unit	(C) Multiple units	(D) Multiple units
Method of installation of tie levels	Progressive installation	Pre-installation	Pre-installation	Pre-installation
Particularities	<ul style="list-style-type: none"> Installation of unit (without tie levels) Progressive installation of tie levels 	<ul style="list-style-type: none"> Complete installation of unit (tie levels to top of work) 	<ul style="list-style-type: none"> Complete installation of first unit (tie levels to top of work) Complete installation of second unit (tie levels to top of work) Installation of bearing bridge structure 	<ul style="list-style-type: none"> Installation of first unit (without tie levels) Installation of bearing bridge structure Installation of second unit (without tie levels) Installation of tie levels to top of work on both units
Equipment and accessories	NOT ALLOWED	Without equipment or accessories	With equipment or accessories	With or without equipment and accessories
Tie schedule(s) appropriate for the installation	1	2	3	4



WARNING
It is important to note that **freestanding configurations are not allowed** for S Series motorized units unless an optional adapter base for freestanding installation is used.

fig. 6.8

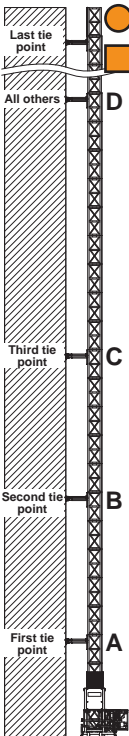

fig. 6.10

Mast Tie Schedule Unit without lateral base extensions				
	1	2	3	4
A (from under base)	10' (3 m)	10' (3 m)	10' (3 m)	10' (3 m)
B (from A)	10' (3 m)	20' (6,1 m)	20' (6,1 m)	20' (6,1 m)
C (from B)	20' (6,1 m)	30' (9,1 m)	30' (9,1 m)	30' (9,1 m)
D (from C)	20' (6,1 m)	45' (13,7 m)	45' (13,7 m)	30' (9,1 m)
Height of mast above last tie level with two tie levels in place	20' (6,1 m)	20' (6,1 m)	NOT ALLOWED	NOT ALLOWED
Height of mast above last tie level with one tie level in place	10' (3 m)	10' (3 m)	NOT ALLOWED	NOT ALLOWED

fig. 6.9

Mast Tie Schedule Unit with lateral base extensions				
	1	2	3	4
A (from under base)	10' (3 m)	20' (6,1 m)	20' (6,1 m)	20' (6,1 m)
B (from A)	10' (3 m)	30' (9,1 m)	30' (9,1 m)	30' (9,1 m)
C (from B)	20' (6,1 m)	45' (13,7 m)	45' (13,7 m)	30' (9,1 m)
D (from C)	20' (6,1 m)	45' (13,7 m)	45' (13,7 m)	30' (9,1 m)
Height of mast above last tie level with two tie levels in place	20' (6,1 m)	20' (6,1 m)	NOT ALLOWED	NOT ALLOWED
Height of mast above last tie level with one tie level in place	10' (3 m)	10' (3 m)	NOT ALLOWED	NOT ALLOWED

Last mast section (installed backwards if no mast heads installed)	Top limit trigger installed on next to last mast section
--	--

Mast Ties

Location of perpendicular mast ties according to configuration

Each type of configuration shown below requires the installation of additional rigid dual clamps. Refer to p. 79 of this section for more information about the installation of additional rigid dual clamps.

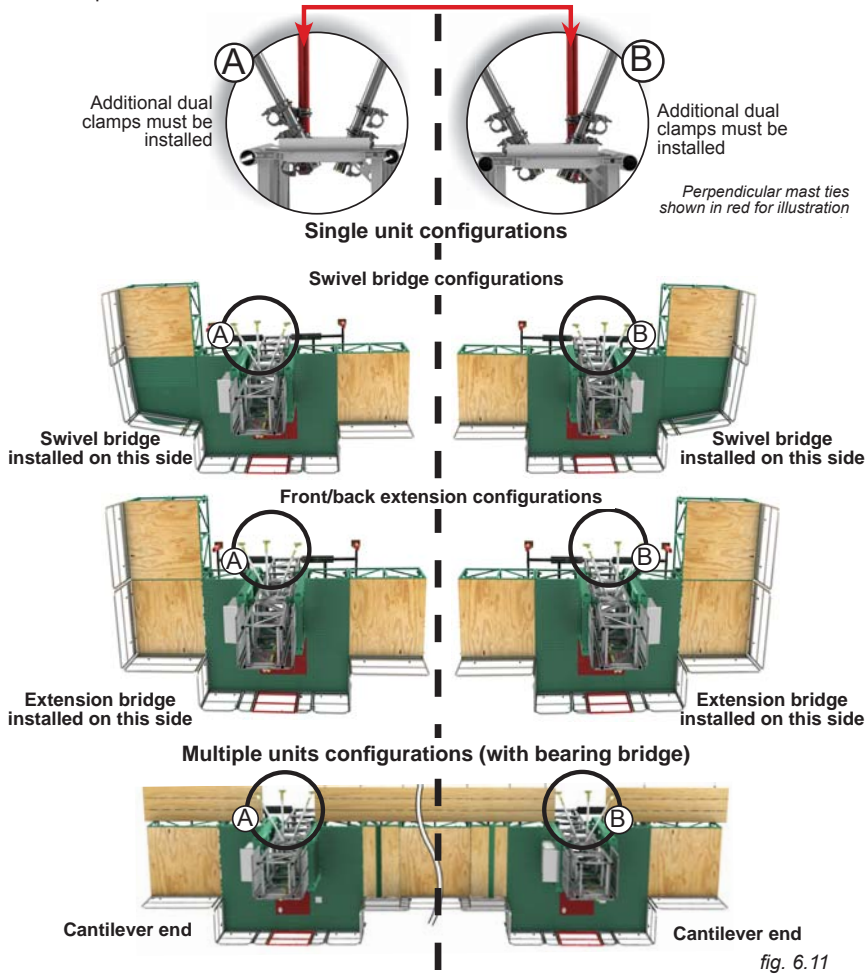

Applies to all multiple units configurations (with bearing bridge) used with or without equipment or accessories.

Recommended order of installation:

- ① Perpendicular mast tie to be installed first
- ② Opposite angled mast tie to be installed second (angled at 25°)
- ③ Third mast tie to tighten the tie installation (angled at 25°)

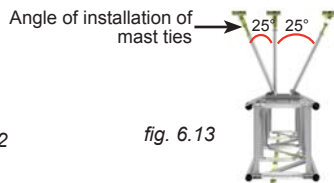
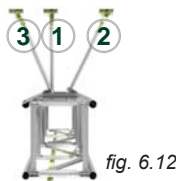

Mast Ties

Installation of mast ties with extensions

In a configuration requiring the use of mast tie extensions, it is important to note that only **one mast tie extension per mast tie is allowed** (a maximum of 60" or 1,5 m). It is **mandatory** to use mast tie braces and additional rigid dual clamps for such tie configurations. For any other mast tie configuration not shown in this owner's manual, contact the distributor/service center or the Hydro Mobile technical support team.

- 1- Insert a mast tie extension into the tube of a 36" (0,9 m) mast tie. Secure in place with two pins (fig. 6.16).
- 2- Install all the rigid dual clamps required and adjust the mast tie. For more information, refer to the installation instructions for standard mast ties on p. 76 and for additional dual clamps hereafter.
- 3- Repeat steps 1 and 2 for the other two mast ties. Once all mast ties are installed, brace the mast ties by installing 36" (0,9 m) mast tie extension tubes secured to the mast tie assemblies with swivel dual clamps (fig. 6.15).
- 4- Make sure all clamps are tightened to 60 lb-ft (80 N-m) of torque.

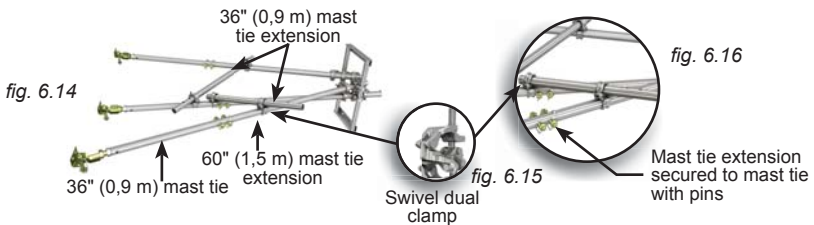

Installation of additional rigid dual clamps to secure the mast tie

In a configuration using either mast tie extensions, or back or forward bridge extensions, a swivel bridge, a hoist, weather protection, etc., the tension / compression factor is highly increased. In such situations, it is **mandatory** to attach an additional rigid dual clamp **behind** and **in front** of the rigid dual clamp attached to the mast tie frame (see fig. 6.18).

- 1- Install the first rigid dual clamp on the vertical tube of the mast tie frame (fig. 6.18). Attach the mast tie to the rigid dual clamp. Tighten the clamp to 60 lb-ft (80 N-m) of torque.
- 2- Lock the installed rigid dual clamp in place by installing additional rigid dual clamps in front and behind as shown in fig. 6.18.

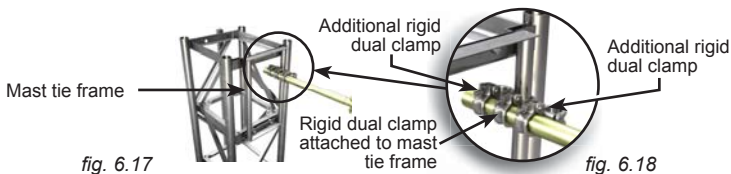

WARNING

It is important to verify each mast tie of an installation that has been exposed to winds exceeding 102 mph (164 km/h).

Mast Ties

Mast tie requirements according to plank configuration

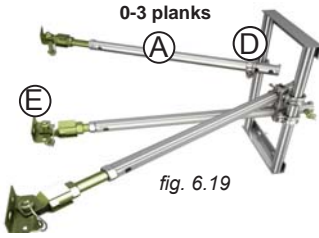

fig. 6.19

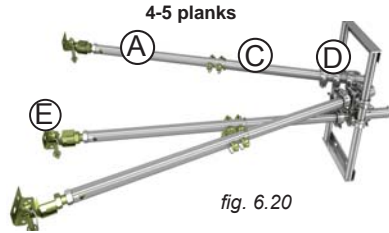

fig. 6.20

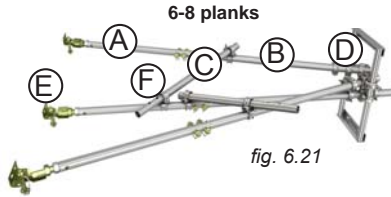

fig. 6.21

fig. 6.22

MAST TIE REQUIREMENTS FOR PLANK CONFIGURATION				
Ref	Component	0-3 PLANKS	4-5 PLANKS	6-8 PLANKS
A	36" (91,4 cm) mast tie assembly	3	3	3
B	60" (1,5 m) mast tie extension assembly			3
C	36" (91,4 cm) mast tie extension assembly		3	2
D	rigid dual clamps	3	9	9
E	wall tie brackets	3	3	3
F	swivel dual clamps			4

Note: Quantities for items will vary according to type of configuration (single or multiple units, swivel bridge, etc.)

WARNING - WIND SPEEDS



Wind speeds must not exceed **28 mph (45 km/h)** during the **erection** and **dismantling** of a motorized unit setup (including the base, the bridges, the masts, the mast ties and all the other components). **Freestanding installations**, when allowed, must not be exposed to wind speeds exceeding **28 mph (45 km/h)**. A motorized unit setup with **mast ties** must not be exposed to wind speeds exceeding **35 mph (56 km/h)** when in **operation**. A motorized unit setup equipped with **weather protection** must not be exposed to wind speeds exceeding **28 mph (45 km/h)**. Wind speeds must not exceed **102 mph (164 km/h)** when the motorized unit setup is **not in use**.

When motorized unit is not in use

- It is mandatory to leave the platform between two anchor points when the motorized unit is not in use.
- Remove all loads from the setup when the motorized unit is not in use.
- It is mandatory to leave all the counterweights applied on the setup in place when the motorized unit is not in use.
- In a freestanding installation, when allowed, the motorized unit must be brought down to base level when not in use.

Mast Ties

Removal of mast ties

- 1- Remove any installed diagonal brace.
- 2- Beginning with one of the angled mast ties (see the "1" in the recommended order of removal, in fig. 6.23, p. 81), loosen the mast tie to release the tension. Make sure that all tension (or compression) is completely released.
- 3- Unpin the mast tie from the wall tie.
- 4- Remove all dual clamps holding the mast tie. Remove and store the mast tie.



fig. 6.24



fig. 6.23

Order of removal
of mast ties

- 5- Repeat steps 2 through 4 with the remaining ties.
- 6- Remove the bolt assemblies holding the mast tie frame to the mast section. Remove and store the mast tie frame.



WARNING

It is **mandatory** to make sure that **all tension (or compression) is released** from the mast tie before attempting to unpin it from the wall tie

Anchoring System

Installation of wall ties

Before attaching masts to the building using the mast tie system, anchor fasteners or any other attachment used to attach wall tie brackets must be installed on a solid part of the building structure able to sustain the loads to be imposed. Concrete slabs, columns, steel beams, relief angles and other structural elements can be used provided they can sustain the tension / compression and shear force of the anchoring installation, as described below. It is recommended to refer to an engineer to validate the capacity of the structure on which the anchoring system will be installed.

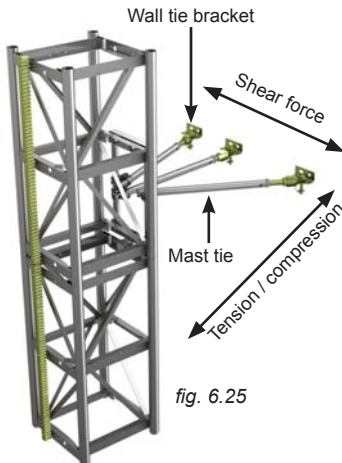

fig. 6.25

Installation of wall tie brackets



fig. 6.26

Each anchor fastener shown in fig. 6.26 should be able to sustain appropriate tension / compression and shear force for the application. Refer to p. 82 of this section for more information. A minimum of six anchor fasteners is required.

Masts and Mast Ties

Anchoring System

Wall tie reactions

Before attaching masts to the building using the mast tie system, wall ties must be installed on a solid component of the building structure. It is important to understand that whether the anchoring installation is a vertical or horizontal type (fig. 6.35 and fig. 6.36), values for tension / compression and shear forces will be **inverted**.

Concrete slabs, columns, steel beams, relief angles and other structural elements can be used provided they and the anchoring system chosen can sustain 3000 lb (1360 kg) of tension / compression and 1500 lb (680 kg) of shear force for a **vertical anchoring installation** and 1500 lb (680 kg) of tension / compression and 3000 lb (1360 kg) of shear force for a **horizontal anchoring installation**.

Wall tie types

There are 4 types of wall ties that can be used – welded, fixed, wall/floor and re-usable. As the installation is rising, install the wall ties as per the appropriate mast tie schedule (see p. 77).

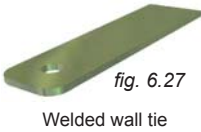

Welded wall tie

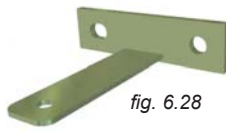

Fixed wall tie
(4" or 10 cm only)



Re-usable wall tie
(welded at bottom)



Wall tie for horizontal
or vertical anchoring
installation



Re-usable wall tie
(welded in center)

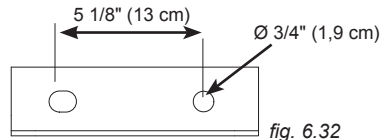

Wall tie bracket template



fig. 6.35

Vertical anchoring
installation

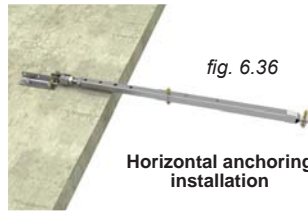

fig. 6.36

Horizontal anchoring
installation

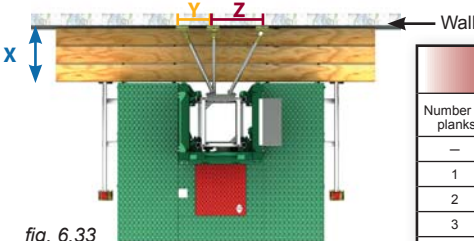

fig. 6.33

fig. 6.34

Wall tie distance for a vertical anchoring installation			
Number of planks	X in (cm)	Y in (cm)	Z in (cm)
—	7" (17,8 cm)	5 1/2" (14 cm)	15" (38,1 cm)
1	17" (43,2 cm)	10 1/2" (26,7 cm)	19 1/2" (49,5 cm)
2	27" (68,6 cm)	15" (38,1 cm)	24 1/2" (62,2 cm)
3	37" (94 cm)	19 1/2" (49,5 cm)	29" (73,7 cm)

Distances above are given as a reference only.

Masts and Mast Ties

Anchoring System

Installation guidelines for horizontal anchoring

Horizontal anchoring can be installed at angles ranging from 0° up to 30° from horizontal. Wall ties used for horizontal anchoring installations must be able to sustain 1500 lb (680 kg) of tension/compression and 3000 lb (1361 kg) of shear force.



fig. 6.37

Type of wall tie used for horizontal anchoring installations

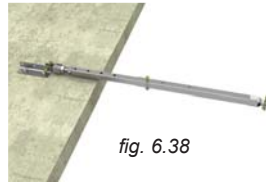

fig. 6.38

Installation guidelines for fixed wall ties

Fixed wall ties can be installed on a wall between two layers of brick (fig. 6.39). It is important to make sure that several layers of brick have been laid on top of the fixed wall ties and that the mortar has cured properly **before attaching mast ties to the wall ties**.

Distance between the anchoring structure and the back of the brick wall must not be greater than 1 1/2" (3,8 cm), as shown in fig. 6.40.



fig. 6.39

Maximum distance
1 1/2" (3,8 cm)

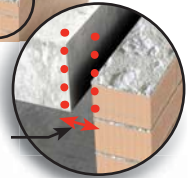

fig. 6.40

Installation guidelines for a welded wall tie on a beam

The welded wall tie is 6 7/8" (17,5 cm) long and should protrude from the beam by a maximum of 3 7/8" (10 cm), as shown in fig. 6.42.

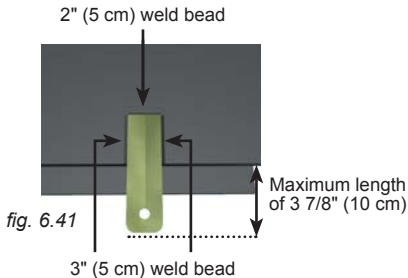

fig. 6.41



fig. 6.42

Wall tie welded to beam

The welded wall tie can be fastened to the beam by three 3/16" (5 mm) wide weld beads. The two weld beads along the length of the wall tie will be 3" (5 cm) long, while the weld bead along the width of the wall tie will be 2" (5 cm) long.

Installation guidelines for a re-usable wall tie

Used mainly for masonry work projects, the re-usable wall tie is installed in a cavity left unfilled in a brick wall under construction. When dismantling the setup and removing mast ties, the re-usable wall tie is removed and the brickwork is completed.



fig. 6.43

Installation of the re-usable wall tie



WARNING

It is important to consider that fixed or reusable wall ties must **only be used for vertical anchoring installations, not horizontal**.

Load Capacities

Load capacity calculation guidelines

- 1- The weight of planks and any additional accessory being used must be deducted from the load capacities.
- 2- Each worker's weight (personal tools and equipment included) must be deducted from load capacities.
- 3- To ensure stability in a **standard single unit setup**, the **length of cantilever bridges** on either side of the unit must be **equal at all times**. It is also recommended that the loads applied on the platform be as evenly distributed as possible.
- 4- It is recommended that there be a **maximum** number of workers for each installation, calculated as follows: overall length of installation divided by 15' (4,6 m) and rounded **up**, **PLUS** two workers for each motorized unit in the installation, with at least one of those two workers being a qualified operator of an S Series motorized unit and its accessories. For example, on a setup with an overall length of 92' 9" (28,3 m), the calculation would be: 92' 9" / 15 (or 28,3 m / 4,6 m) rounded up to **7**, **PLUS two workers for each motorized unit** (in this case, two units) = **4**, resulting in a **maximum of 11 workers** for the installation, including **two qualified operators**. Refer to p. 5 of the *Performance and Safety Rules* section for the definition of a qualified operator.
- 5- The weight of each person working in a given area reduces the load capacity of that area.
- 6-  **The load capacities charts stickers displayed on the motorized unit used in the setup will take precedence over the information included in this owner's manual.**
- 7- In the single unit and multiple unit installation charts shown in the following pages, the 5' (1,5 m) bridge is used to illustrate capacities. On setups using 10' (3 m) bridges, the load deposited on the 10' (3 m) bridge must be distributed in the same way it is distributed over two 5' (1,5 m) bridges on the chart, as shown in fig. 6.1, below.

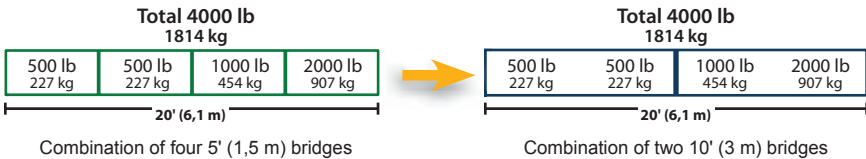

fig. 6.1

- 8- To calculate the load capacity of a standard, authorized single or multiple unit configuration that is not shown in the charts included in this manual, take the length of the bridge to be installed and refer to the capacities of the bridge in the chart that is longer and closest to it. For example, for a 47' 6" (14,5 m) bearing bridge, the load capacities of a 50' (16 m) bearing bridge would be used.



WARNING

To ensure safety at all times on a mast climbing work platform system, bridges must not be loaded beyond their maximum rated load capacities. In addition, to prevent a mast climbing work platform system from stalling because of an overload, maximum rated load capacities of the motorized unit(s) should be observed. Overloading a mast climbing work platform system could result in serious injury or death.

In a multiple unit setup equipped with weather protection, the maximum length of cantilever bridges on either side of the setup is 15' (4,6 m).

Make sure that there are never two workers standing on the same plank outrigger at the same time.

Load Capacities

Single unit installation

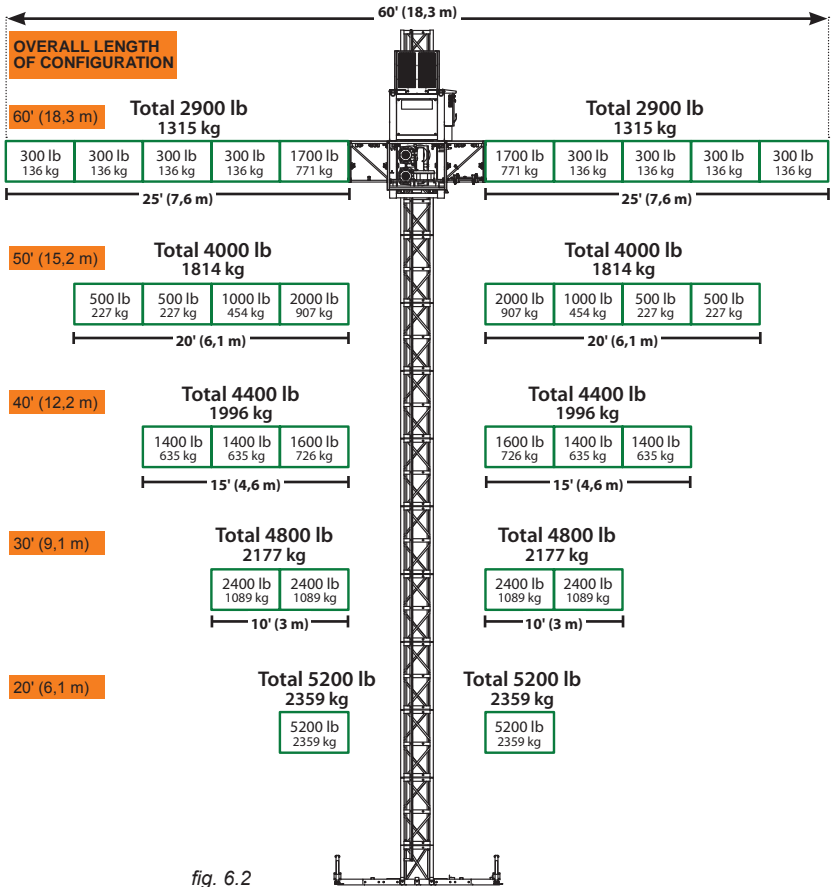

fig. 6.2

Calculating the maximum number of workers allowed on a given installation

<p>Formula</p> <p>Overall length of installation / 15' (4,6 m), rounded up</p> <p style="text-align: center;">+</p> <p>Two (2) workers per motorized unit in the installation</p>	<p>Calculation example for a 92' 9" (28,3 m) installation</p> <p>92' 9" (28,3 m) / 15' (4,6 m), rounded up → 7</p> <p style="text-align: center;">+</p> <p>Two (2) workers for each motorized unit in the installation → 4</p> <hr/> <p>Total of workers allowed on installation → 11</p>
--	--

LEGEND

5' (1,5 m) bridge assembly	Length of bridge setup
----------------------------	------------------------

To ensure safety at all times, refer to load calculation guidelines and warnings on p. 84.

Load Capacities

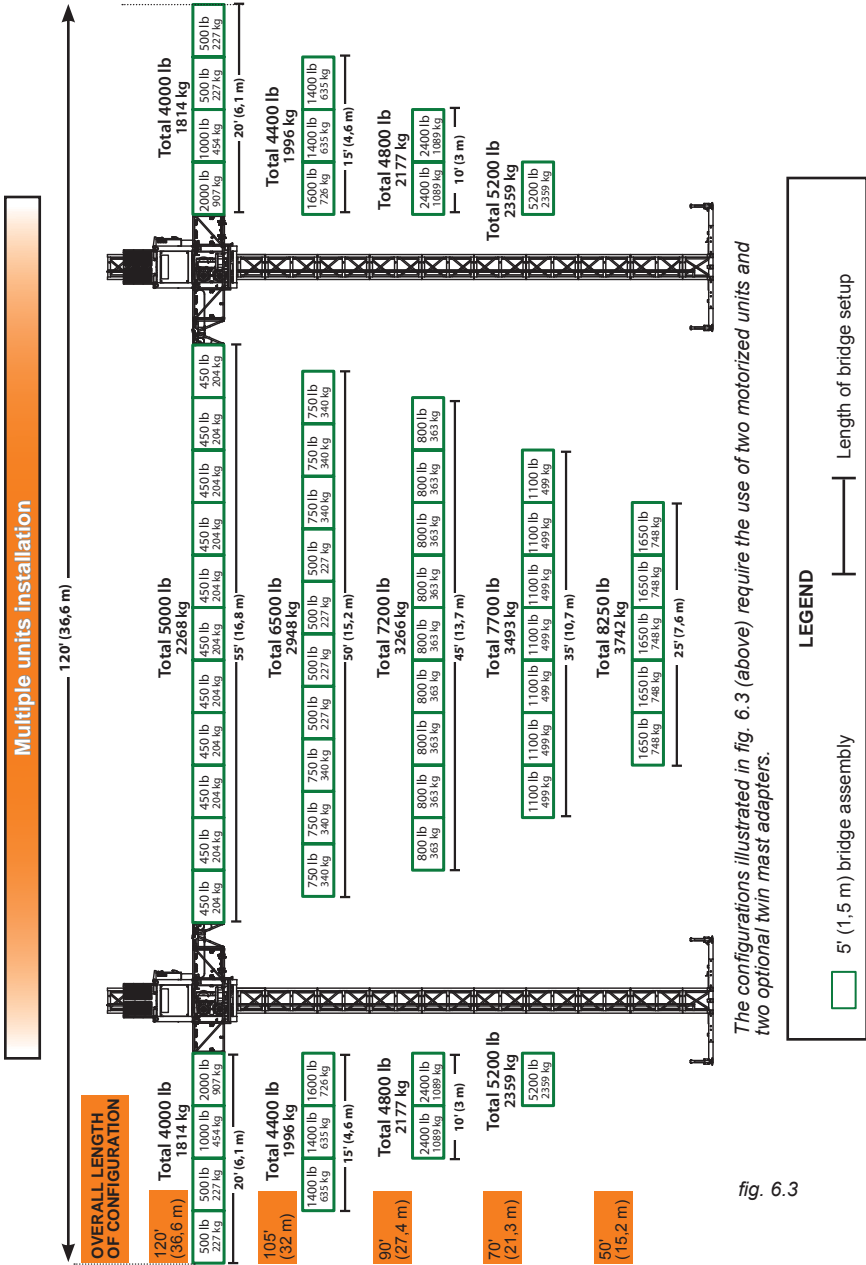

The configurations illustrated in fig. 6.3 (above) require the use of two motorized units and two optional twin mast adapters.

fig. 6.3

 To ensure safety at all times, refer to load calculation guidelines and warnings on p. 84.

Load Capacities

Forward extension installation – using a standard bridge

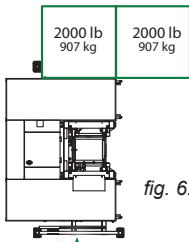

fig. 6.4

At this end, it is mandatory to install a bridge. The only bridge configurations allowed at this end are the following:

Any cantilever bridge configuration (see fig. 6.2, p. 85)

— OR —

any bearing bridge configuration (see fig. 6.3, p. 86)

— OR —

any forward extension configuration shown in this chart.

NO CONFIGURATION OTHER THAN THOSE ABOVE ALLOWED AT THIS END

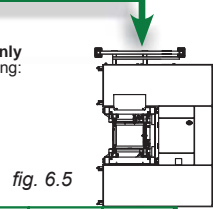
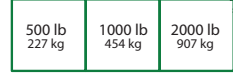

fig. 6.5



Forward extension installation – using a multi purpose bridge

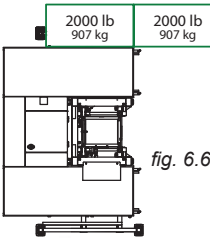

fig. 6.6

At this end, it is mandatory to install a bridge. The only bridge configurations allowed at this end are the following:

Any cantilever bridge configuration (see fig. 6.2, p. 85)

— OR —

any bearing bridge configuration (see fig. 6.3, p. 86)

— OR —

any forward extension configuration shown in this chart.

NO CONFIGURATION OTHER THAN THOSE ABOVE ALLOWED AT THIS END

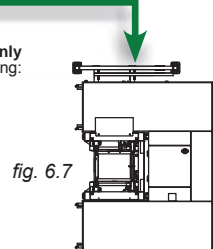

fig. 6.7



Swivel bridge installation – Single unit (0-45 degrees)

At this end, it is mandatory to install a bridge. The only bridge configurations allowed at this end are the following:

Any cantilever bridge configuration (see fig. 6.2, p. 85)

— OR —

any bearing bridge configuration (see fig. 6.3, p. 86)

— OR —

any swivel bridge extension configuration shown in this chart.

NO CONFIGURATION OTHER THAN THOSE ABOVE ALLOWED AT THIS END

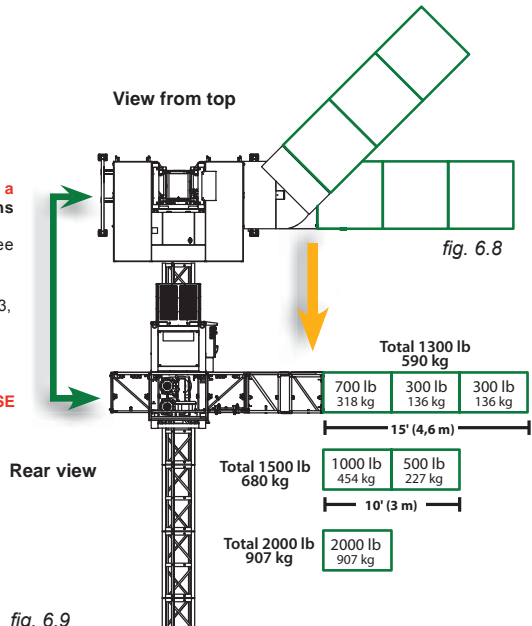

fig. 6.9

Load Capacities

Swivel bridge installation – Single unit (90 degrees)

At this end, it is mandatory to install a bridge.
 The **only** bridge configurations allowed at this end are the following:

Any cantilever bridge configuration (see fig. 6.2, p. 85)

— OR —

any bearing bridge configuration (see fig. 6.3, p. 86)

— OR —

any swivel bridge extension configuration shown in this chart.

NO CONFIGURATION OTHER THAN THOSE ABOVE ALLOWED AT THIS END

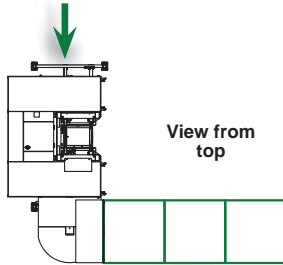

fig. 6.10

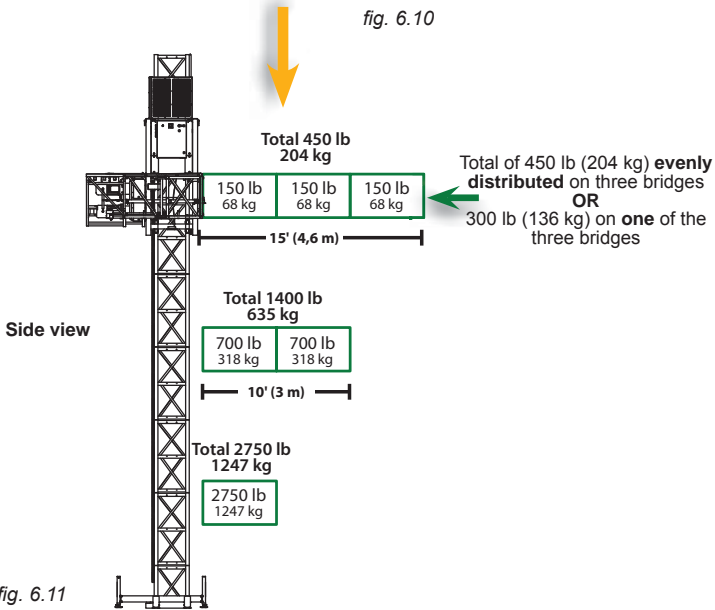

fig. 6.11

LEGEND

5' (1,5 m) bridge assembly
 Length of bridge setup

To ensure safety at all times, refer to load calculation guidelines and warnings on p. 84.

Load Capacities

Swivel bridge installation – Multiple units

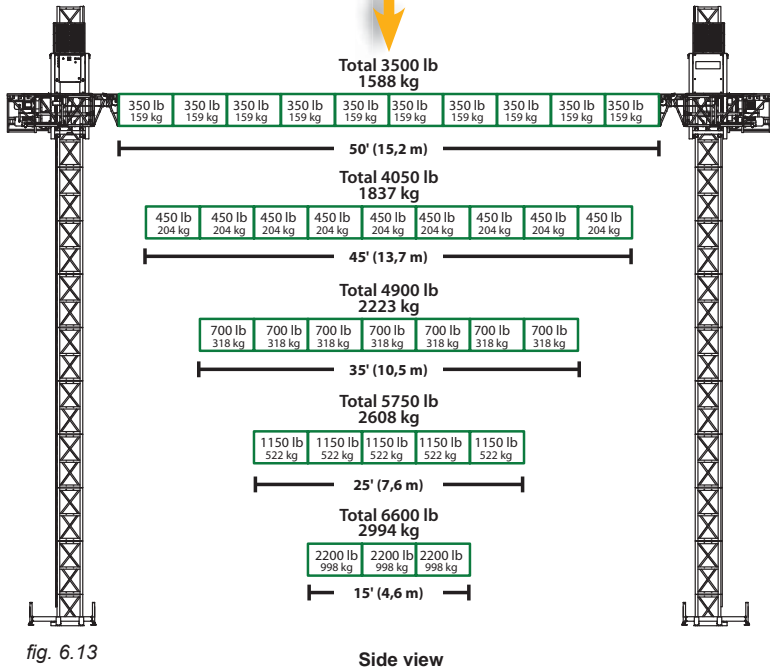
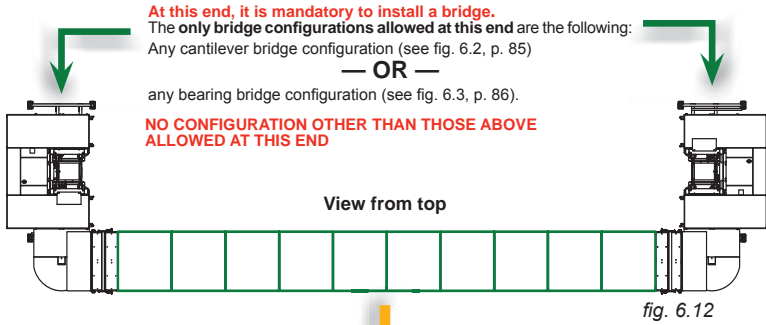

The configurations illustrated in fig. 6.13 (above) require the use of two motorized units and two optional twin mast adapters in addition to the swivel bridges.

LEGEND

5' (1,5 m) bridge assembly

Length of bridge setup

To ensure safety at all times, refer to load calculation guidelines and warnings on p. 84.

Load Capacities

Swivel bridge installation with counterweight adapter – three bridges

At this end, it is mandatory to install a bridge. The only bridge configurations allowed at this end are the following:

Any cantilever bridge configuration (see fig. 6.2, p. 85)

— OR —

any bearing bridge configuration (see fig. 6.3, p. 86).

NO CONFIGURATION OTHER THAN THOSE ABOVE ALLOWED AT THIS END

Example of calculation of the load capacity of an additional bridge structure when using a 2250 lb (1021 kg) counterweight

LEFT cantilever bridge structure, single unit installation

300 lb 136 kg	300 lb 136 kg	300 lb 136 kg	300 lb 136 kg	1700 lb 771 kg	Total 2900 lb 1315 kg
Evenly distributed OR distributed among a given number of bridges					
					BECOMES
					Total 1900 lb 862 kg

Heavier loads must always be placed closer to the unit

Applies to setup shown at bottom below

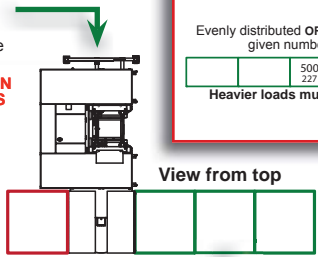

fig. 6.14

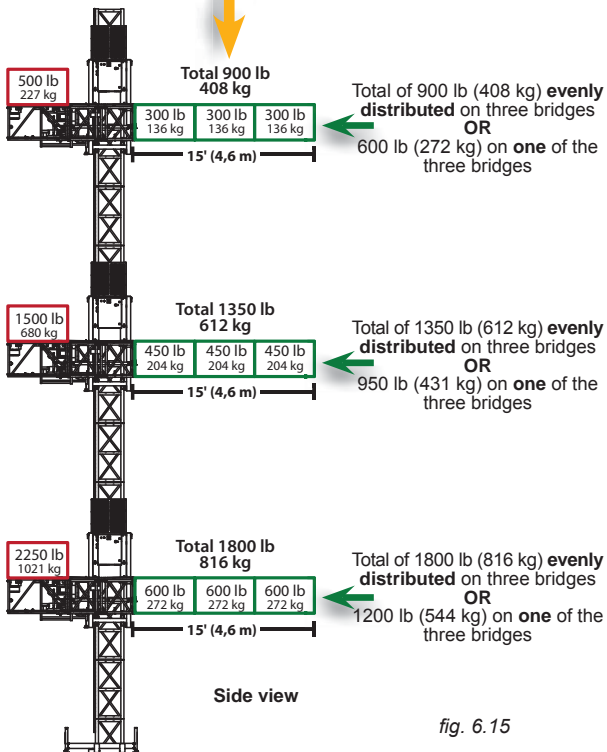

fig. 6.15

When using a 2250 lb (1021 kg) counterweight, deduct 1000 lb (454 kg) from the total load capacity of any configuration installed at this end

LEGEND

5' (1,5 m) bridge assembly

Length of bridge setup

To ensure safety at all times, refer to load calculation guidelines and warnings on p. 84.

Load Capacities

Swivel bridge installation with counterweight adapter – two bridges

At this end, it is mandatory to install a bridge. The only bridge configurations allowed at this end are the following:

Any cantilever bridge configuration (see fig. 6.2, p. 85)

— OR —

any bearing bridge configuration (see fig. 6.3, p. 86).

NO CONFIGURATION OTHER THAN THOSE ABOVE ALLOWED AT THIS END

Example of calculation of the load capacity of an additional bridge structure when using a 1500 lb (680 kg) counterweight

LEFT cantilever bridge structure, single unit installation

300 lb 136 kg	300 lb 136 kg	300 lb 136 kg	300 lb 136 kg	1700 lb 771 kg	Total 2900 lb 1315 kg
Evenly distributed OR distributed among a given number of bridges					
		500 lb 227 kg	500 lb 227 kg	900 lb 408 kg	Total 1900 lb 862 kg

Heavier loads must always be placed closer to the unit

Applies to setup shown at bottom below

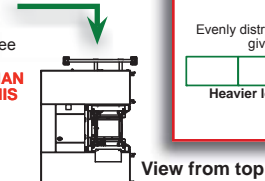

fig. 6.16

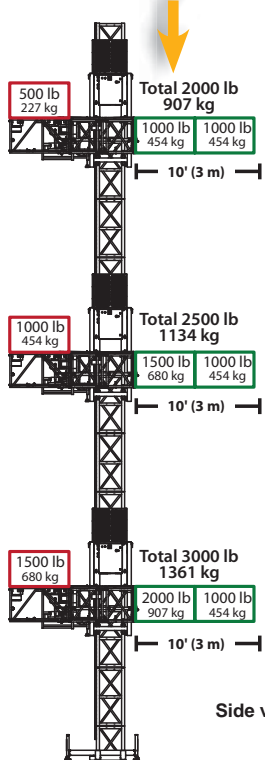

fig. 6.17

When using a 1500 lb (680 kg) counterweight, deduct 1000 lb (454 kg) from the total load capacity of any configuration installed at this end

LEGEND

5' (1,5 m) bridge assembly

Length of bridge setup

To ensure safety at all times, refer to load calculation guidelines and warnings on p. 84.

Load Capacities

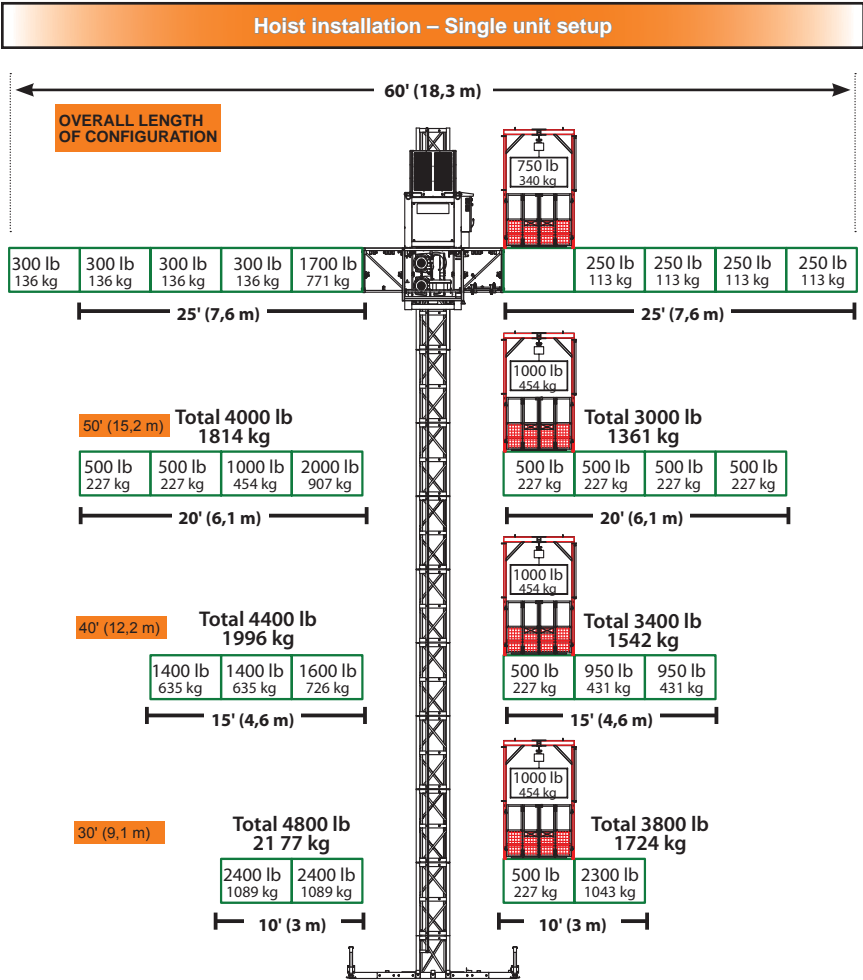

fig. 6.18

The configurations illustrated in fig. 6.18 (above) require the use of an optional hoist support structure. Load capacities shown above are based on the use of an electric hoist weighing 250 lb (113,4 kg).

LEGEND	
5' (1,5 m) bridge assembly	Length of bridge setup
To ensure safety at all times, refer to load calculation guidelines and warnings on p. 84.	

Load Capacities

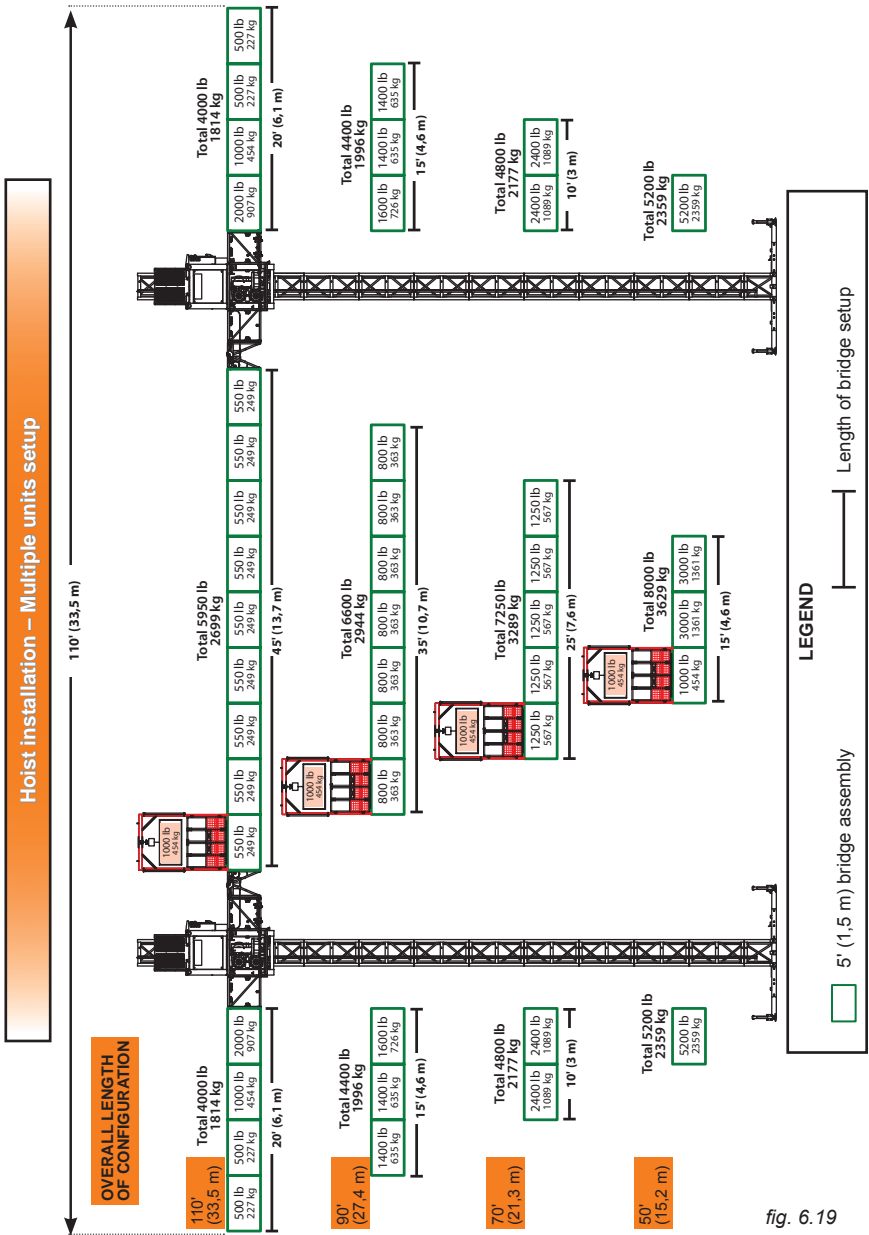

fig. 6.19

The configurations illustrated in fig. 6.19 (above) require the use of two motorized units, two optional twin mast adapters and an optional hoist structure. Load capacities shown above are based on the use of an electric hoist weighing 250 lb (113,4 kg).



To ensure safety at all times, refer to load calculation guidelines and warnings on p. 84.

Safety Accessories

SAFETY comes first. While most hazards that may occur when operating an S Series motorized unit setup can be avoided by using extreme care and common sense, the use of safety accessories, such as appropriate guardrails and plank support outriggers, is recommended when areas and activities involve heights or positioning of the setup that put workers at risk.

Guardrails

In all cases where workers are exposed to fall hazards greater than specified by local regulations, the installation of appropriate guardrails is **mandatory** to ensure safety.

Installation of a standard bridge guardrail

- 1- Slide a guardrail adapter L bracket (fig. 8.2) in each of the two guardrail pockets at the top of the bridge (see fig. 3.1, p. 41 of the *Bridges* section) and secure them with toggle pins.
- 2- Insert the guardrail legs in the vertical part of the adapter brackets and tighten the bolts on the adapter brackets to secure the guardrail.
- 3- Install as many guardrails as is required by the setup. Make sure that all guardrails are appropriately locked together (fig. 8.3).

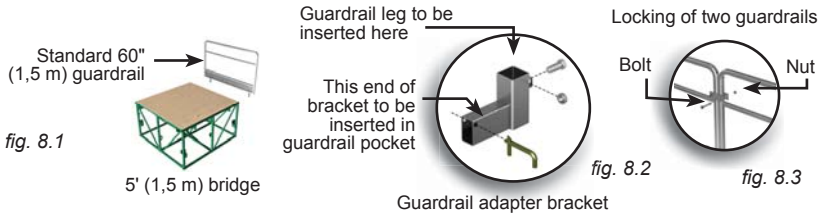

Face Guardrail Supports (optional)

Face guardrail supports must be installed when the distance between the end of planking (or deck, if not using planks) and the structure is greater than what local regulations allow or 6" (15 cm) (ex. recess in a wall, end of a building, etc.), the most stringent of conditions taking precedence over the others. On all S Series motorized units and bridges, the face guardrail supports can be installed at the **bottom** or **top** outrigger position.

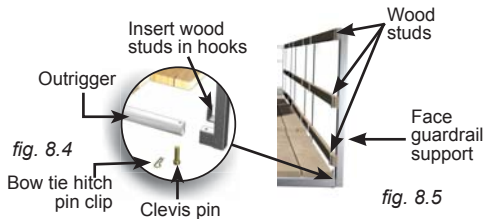

Installation

- 1- Remove the plank stop pin from the outrigger and slide the face guardrail support over the outrigger tube.
- 2- Secure in place by sliding the supplied clevis pin through the face guardrail support and the outrigger. Secure the support in place with a bow tie hitch pin clip and tighten all the outrigger pocket bolts properly.
- 3- Repeat steps 1 and 2 for each guardrail face support required to secure the hazardous opening.
- 4- Insert wood studs in the hooks of each face guardrail support to cover the hazardous opening. It is important to make sure to use 2" x 6" (5 cm x 15 cm) wood studs at the bottom position. Secure the studs in place with nails or screws.



WARNING

It is important to make to use 2" x 6" (5 cm x 15 cm) wood studs at the bottom position.

Safety Accessories

Guardrails

Movable Guardrail (optional)

To ensure the safety of workers in a more flexible way, movable guardrails may be installed on bridges. Follow the installation steps of a standard guardrail and secure the movable guardrail to the standard guardrail with toggle pins.

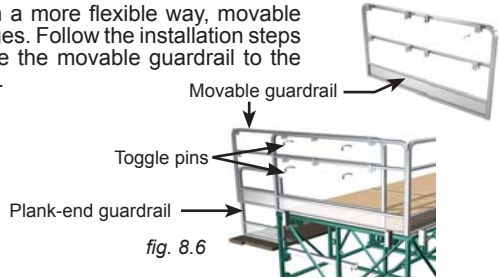

Plank-End Guardrail

Plank-end guardrails must be installed at the ends of planking as fall protection. In a three-plank configuration, the opening must be closed by placing two plank-end guardrails **face to face**.

Overlapped plank-end guardrails



Installation

- 1- Slide the bottom end of the plank-end guardrail over the end of two planks.
- 2- Drive one or two nails or screws into the planks through the top plate to secure the guardrail in place.
- 3- A three-plank configuration will require the installation of two plank-end guardrails. Follow steps 1 and 2 to install the first plank-end guardrail.
- 4- Slide a second plank-end guardrail second guardrail backwards over the end of two planks, overlapping the first one installed. Secure the second guardrail in place as described in step 2.

fig. 8.11



Universal Plank Safety Support (optional)

The universal plank safety support is installed at the extremities of planking to prevent planks from lifting, tipping and slipping.

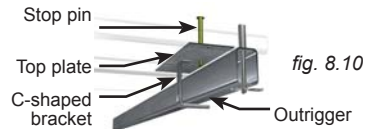

Installation

- 1- Remove the stop pin (fig. 8.3) and slide the plank safety support between two planks.
- 2- Secure the C-shaped bracket around the outrigger and replace the stop pin.
- 3- Using screws or nails, secure the top plate of the plank safety support to the planks (fig. 8.9).

Accessories

Access Stairs

When the motorized unit is at base level, workers may use the access stairs to reach the platform. The access stairs can be installed centered on the back of the S Series motorized unit main frame or on a bridge in the setup.

Installation

- 1- Install the guardrail door by sliding the guardrail legs in the guardrail pockets on the bridge or the motorized unit. Secure the guardrail door with two toggle pins.
- 2- Slide the top part of the stairs into the top outrigger pockets (fig. 8.15).
- 3- Unfold the stair brace.
- 4- Secure the stair brace to the hinged tube on the main frame of the unit (fig. 8.14) or the bottom truss of the bridge (fig. 8.13) with two toggle pins.
- 5- Secure the top part in place by sliding in two toggle pins and tightening each outrigger pocket bolt.
- 6- Install the railings and secure in place and tighten the bolts.
- 7- If the height between the bearing surface and the first step is greater than what is allowed by local regulations, it is mandatory to install one or more optional extension stair. A **maximum** of two (2) extension stairs is allowed per access stair installation.

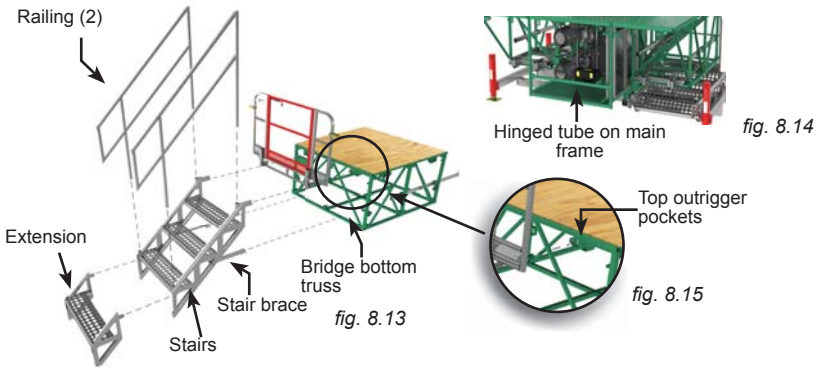

Bridge Installation Support Bracket (optional)

fig. 8.16

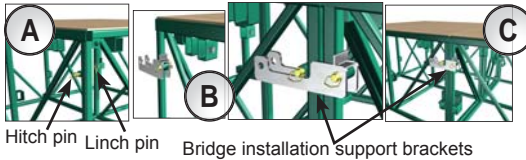

fig. 8.12

- The use of the bridge installation support brackets requires that at least two persons handle the bridge installation maneuvers. Bridge installation support brackets are used whenever a bridge must be lifted by hand and no appropriate lifting device is available.
- Step A:** Under the bridge to be installed, slide hitch pins in the designated holes on both sides of the bridge and secure them with lynch pins.
 - Step B:** Using other hitch pin and lynch pin assemblies, attach the bridge installation support brackets to the bridge already bolted to the motorized unit or the bridge.
 - Step C:** Lift the bridge to be installed and lower it down so that the hitch pins are completely supported by the bridge installation support brackets. Assemble the bridges using the appropriate bolts and nuts. Remove the brackets when the bridges are bolted together.



NOTE

Bridge installation support brackets can only be used to attach a bridge to another bridge, not to a motorized unit.

Outriggers

Outriggers can be installed on two levels on S Series motorized units and bridges, top and bottom. Plank support outriggers are not designed to support the weight of material.

Plank support outriggers must be installed 5' (1,5 m) from one another. The size and number of outriggers required will vary according to the planking configuration. Planking configurations of four to eight planks will require the use of additional, optional components such as longer outriggers and cross boxes. Refer to the *Outrigger Selection* table (fig. 8.17) for more information about the size and number of outriggers required for each planking configuration. Refer also to p. 98 for more information on the installation and use of doubled outriggers.

For any outrigger configuration other than those described in this owner's manual, contact the Hydro Mobile technical support team.

Planking configurations

Outrigger Selection		
Planking configuration	Outrigger size	
3 planks (standard configuration)	2 1/2" x 1 1/2" x 1/8" x 63" (6,4 cm x 3,8 cm x 0,3 cm x 160 cm) (standard outrigger, as provided with unit or bridge)	SINGLE
4 planks	2 1/2" x 1 1/2" x 3/16" x 72" (6,4 cm x 3,8 cm x 0,5 cm x 183 cm)	SINGLE
5 planks	2 1/2" x 1 1/2" x 1/4" x 84" (6,4 cm x 3,8 cm x 0,6 cm x 213 cm)	SINGLE
6 planks	2 1/2" x 1 1/2" x 1/4" x 120" (6,4 cm x 3,8 cm x 0,6 cm x 305 cm)	DOUBLED
7 planks	2 1/2" x 1 1/2" x 1/4" x 120" (6,4 cm x 3,8 cm x 0,6 cm x 305 cm)	DOUBLED
8 planks	2 1/2" x 1 1/2" x 1/4" x 120" (6,4 cm x 3,8 cm x 0,6 cm x 305 cm)	DOUBLED

fig. 8.17

Planking configuration guidelines

Planking configuration – width allowed on installation			
Number of planks	Motorized unit	Bearing bridge	Cantilever bridge(s)
0 to 3 planks	100% of total width	100% of total width	100% of total width
4 to 8 planks	100% of total width	50% of total width	Max width 5' (1,5 m)

fig. 8.18

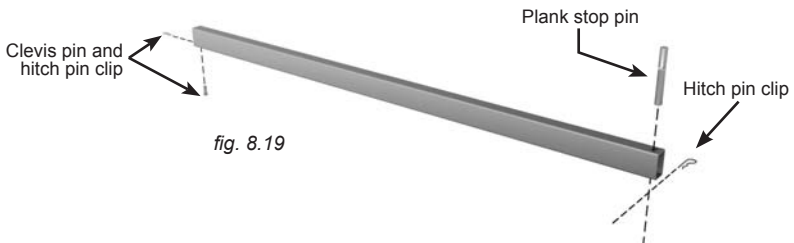
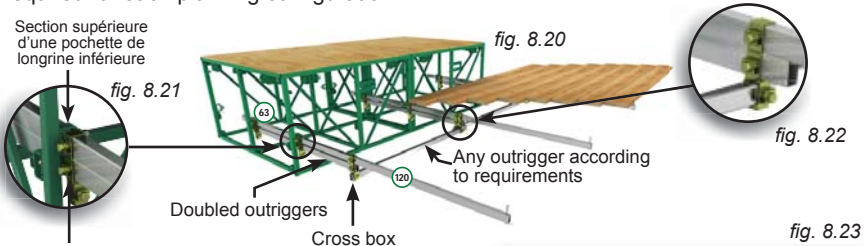

fig. 8.19

Outriggers

Doubled outriggers (optional)

Planking configurations of six, seven and eight planks wide require the use of doubled outriggers and optional cross boxes. A doubled outrigger can be a combination of a longer, thicker outrigger doubled with a standard 63" (1,6 m) or 72" (1,8 m) outrigger. Refer to the *Outrigger Selection* table (fig. 8.17, p. 97) for more information on the outrigger size required for each planking configuration.



Outriggers Required For Doubling	
Ref	Outrigger
63	2 1/2" x 1 1/2" x 1/8" x 63" (6,4 cm x 3,8 cm x 0,3 cm x 160 cm)
120	2 1/2" x 1 1/2" x 1/4" x 120" (6,4 cm x 3,8 cm x 0,6 cm x 305 cm)

Installation

- 1- Remove the clevis pin and the plank stop pin (fig. 8.19, p. 97) and slide one outrigger in the bottom outrigger pockets on the motorized unit or the bridge.
- 2- Slide the **top section** of a cross box on the outrigger until it is about halfway through (fig. 8.21). Slide the **top section** of a second cross box on the end of the outrigger (fig. 8.22). Hand tighten the bolt on the cross boxes to hold them in place.
- 3- Remove the clevis pin and the plank stop pin and slide the second outrigger into the **middle section** of the cross box until its end is pushed in by about 6" (15 cm) from the end of the top outrigger.
- 4- Insert a clevis pin into the top outrigger (fig. 8.25) and pull it up until its head is snug against the outrigger.
- 5- Still holding up the clevis pin on the top outrigger, pull out the bottom outrigger until both outriggers are even (fig. 8.24). Secure the clevis pin on the top outrigger with a hitch pin clip. Insert a clevis pin in the bottom outrigger and secure it in place with a hitch pin clip.
- 6- Tighten the bolts on all the outrigger pockets and on the top and middle sections of the cross boxes to a torque of 30 lb-ft (41 N-m).

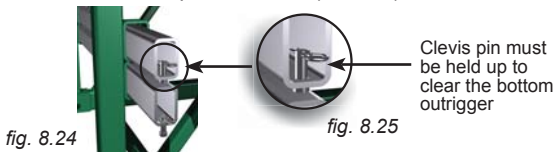

- 7- Repeat steps 1 through 6 for each doubled outrigger required.
- 8- Once all required doubled outriggers are installed, slide a transverse outrigger through the bottom section of the cross boxes on the end of the doubled outriggers (fig. 8.20). Secure in place by tightening the bottom bolt on the cross boxes to a torque of 30 lb-ft (41 N-m).



A doubled outrigger can be a combination of a longer, thicker outrigger doubled with a standard 63" (1,6 m) or 72" (1,8 m) outrigger.

Outriggers

Cross Boxes (optional)

Cross boxes are used to install auxiliary outriggers, as required when planking the inside corner of a forward extension or the recessed area in a wall. Cross boxes are also used when doubling outriggers is required.

Installation

- 1- Remove the clevis pin, hitch pin clip and plank stop pin (fig. 8.19, p. 97) from two outriggers.
- 2- Slide a cross box on the back and the front of each of the two outriggers (fig. 8.26). Replace the clevis pin, hitch pin clip and plank stop pin on each outrigger and tighten the pocket bolts on both outriggers.

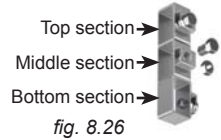
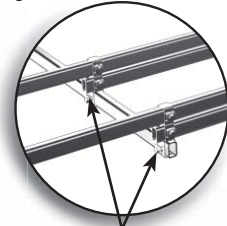

fig. 8.27



Cross boxes installed on the front of two outriggers

- 3- Slide the cross outriggers through the cross boxes until they are halfway through.
- 4- Install a cross box on each cross outrigger and extend each outrigger in position.
- 5- Slide auxiliary outriggers through the cross boxes on the cross outriggers until they are in position. Secure them in place with a clevis pin and a hitch pin clip. Install a plank stop pin in each of the auxiliary outriggers.
- 6- Once the planks are in place, adjust the auxiliary outriggers until the plank stop pins rest snugly against the planks.
- 7- Secure the outriggers in place by tightening all the bolts on the cross boxes to a torque of 30 lb-ft (41 N-m).

Non Standard Planking Configurations

Special planking configurations may be required according to job site requirements, to install planking in areas not covered by standard planking. **Only the following three** non standard planking configurations are **allowed**. The following planking configurations will require the use of optional cross boxes and, in some cases, optional 120" (305 cm) outriggers. It is mandatory to install the cross boxes as close to the bridge outrigger pockets as possible.

Non Standard Planking Configuration #1

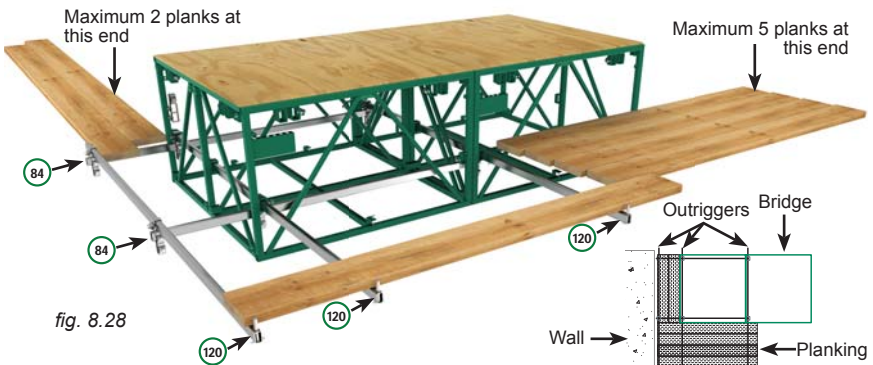

fig. 8.28

fig. 8.29

Outriggers Required for Non Standard planking Configuration #1		
Ref	Quantity	Outrigger
84	2	2 1/2" x 1 1/2" x 1/4" x 84" (6,4 cm x 3,8 cm x 0,6 cm x 213 cm)
120	3	2 1/2" x 1 1/2" x 1/4" x 120" (6,4 cm x 3,8 cm x 0,6 cm x 305 cm)

fig. 8.30

Outriggers

Non Standard Planking Configurations

Non Standard Planking Configuration #2

fig. 8.31

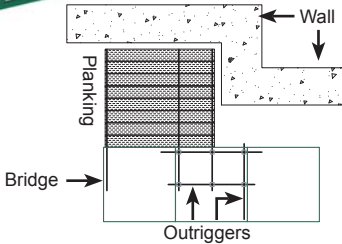
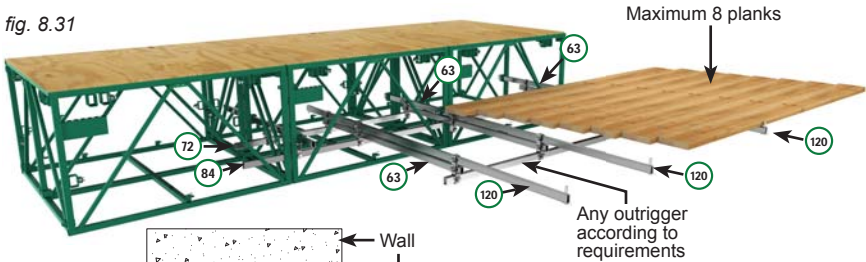

This planking configuration can be used for planking recessed areas

fig. 8.32

Outriggers Required for Non Standard planking Configuration #2		
Ref	Quantity	Outrigger
63	3	2 1/2" x 1 1/2" x 1/8" x 63" (6,4 cm x 3,8 cm x 0,3 cm x 160 cm)
72	1	2 1/2" x 1 1/2" x 3/16" x 72" (6,4 cm x 3,8 cm x 0,5 cm x 183 cm)
84	1	2 1/2" x 1 1/2" x 1/4" x 84" (6,4 cm x 3,8 cm x 0,6 cm x 213 cm)
120	3	2 1/2" x 1 1/2" x 1/4" x 120" (6,4 cm x 3,8 cm x 0,6 cm x 305 cm)

fig. 8.33

Non Standard Planking Configuration #3

Maximum 5 planks



fig. 8.34

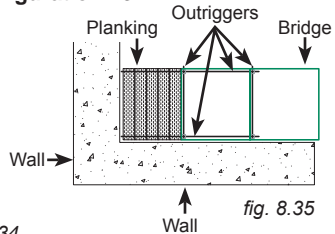

fig. 8.35

Outriggers Required for Non Standard planking Configuration #3		
Ref	Quantity	Outrigger
63	2	2 1/2" x 1 1/2" x 1/8" x 63" (6,4 cm x 3,8 cm x 0,3 cm x 160 cm)
120	2	2 1/2" x 1 1/2" x 1/4" x 120" (6,4 cm x 3,8 cm x 0,6 cm x 305 cm)

fig. 8.36

Outriggers

Outriggers – Top position (optional)

Outriggers used at the top position can be installed either from the **front** or the **back** of the motorized unit or the bridge.

In a configuration where 63" (160 cm) outriggers are used at the **top** position only, the maximum width of planking allowed is **three** planks. In a configuration where 63" (160 cm) outriggers are used at both the **top** and **bottom** position (fig. 8.37, p. 101), the maximum width of planking allowed at the **top** position is **two** planks. Refer to the *Outrigger Selection* table (fig. 8.17, p. 97) and the planking configuration guidelines for more information.

Each outrigger installed at the top position has a maximum capacity of 265 lb (120 kg) and can be used for workers and material.

Installation

- 1- Remove the clevis pin and the plank stop pin (fig. 8.19, p. 97) and slide the outrigger in the top outrigger pockets on the motorized unit or the bridge, leaving no more than 20" (50,8 cm) protruding from the structure if bottom outriggers are installed, or no more than 31" (78,7 cm) if there are no bottom outriggers installed. Replace the clevis pin and the plank stop pin.
- 2- Once the planks are in place, push in each outrigger until the plank stop pin rests snugly against the planks.
- 3- Secure the outriggers in place by tightening the outrigger pocket bolts to a torque of 30 lb-ft (41 N-m).

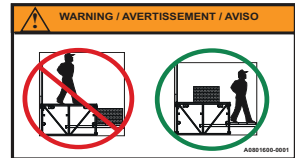
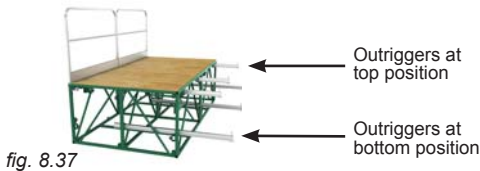

Outriggers – Bottom position

Outriggers used at the bottom position can be installed either from the **front** or the **back** of the motorized unit or the bridge. Each outrigger at the bottom position can be used by **workers only** (including personal tools and equipment). The bottom outriggers **cannot be used** to store material, tools, equipment or to support any other load. In a configuration where 63" (160 cm) outriggers are used at the **bottom** position, the maximum width of planking allowed is **three** planks. Refer to the *Outrigger Selection* table (fig. 8.17, p. 97) and the planking configuration guidelines for more information.

Installation

- 1- Remove the clevis pin and the plank stop pin (fig. 8.19, p. 97). Slide the outrigger in the bottom outrigger pockets on the motorized unit or the bridge, leaving no more than 31" (78,7 cm) protruding from the structure. Replace the clevis pin and the plank stop pin.
- 2- Once the planks are in place, push in each outrigger until the plank stop pin rests snugly against the planks.
- 3- Secure the outriggers in place by tightening the outrigger pocket bolt to a torque of 30 lb-ft (41 N-m).

Multiple Mast Handler (optional)

The use of the multiple mast handler will allow the qualified erector/dismantler to install pre-assembled lengths of mast (also referred to as “sticks”) and reduce the time required to achieve the assembly of the mast.

Installation

- 1- Pre-assemble a length of mast sections on the ground. Mast sections must be laid down horizontally on the ground. For instructions on the assembly of mast sections, refer to p. 74 of the *Mast and Mast Ties* section. Tighten all bolts to 150 lb-ft (203 N-m).
The length of pre-assembled mast allowed will be equal to the authorized height of mast in feet (meters) between two tie levels for the configuration, according to the selected method of installation and the mast tie schedule specific to that method of installation.
For more information about methods of installation, refer to p. 16 of the *Motorized Unit* section. Refer also to the *Mast Tie Schedule* tables on p. 77 for information about distances between tie levels.
- 2- Install the mast handler on the highest step of the lowest mast section of the pre-assembled length of mast (fig. 8.39).

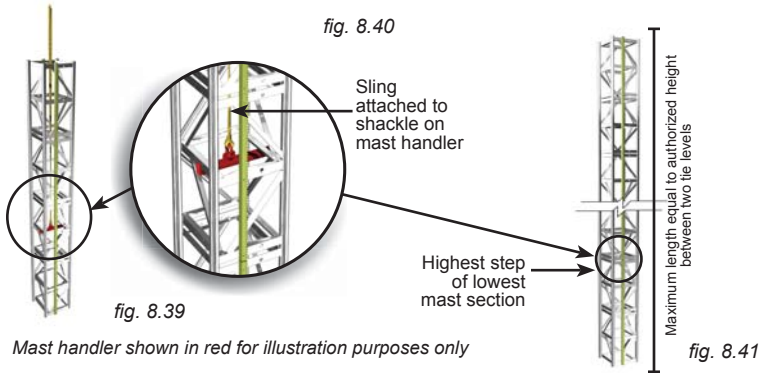

It is important to consider the weight of the pre-assembled length of mast that must be lifted and to make sure to select a sling, chain or cable that can lift that weight. For example, a pre-assembled 45' (13,7 m) length of one-rack mast sections will weigh 2970 lb (1347 kg), while a pre-assembled length of two-rack mast sections will weigh 3285 lb (1490 kg).

- 3- Insert the sling (or chain or cable) through the pre-assembled length of mast and attach the hook to the shackle on the mast handler.
- 4- Using a crane (or a forklift), carefully lift and lower the pre-assembled length of mast on top of the last mast section installed.
- 5- Still holding the length of mast, attach the bottom mast section to the top of the mast section already installed. For instructions on the assembly of mast sections, refer to p. 74 of the *Mast and Mast Ties* section. Tighten all bolts to 150 lb-ft (203 N-m).
- 6- Remove the shackle from the mast handler to release the hook and sling.
- 7- Remove the mast handler from the mast section.
- 8- Raise the motorized unit on the newly added length of mast and install the next tie level.
- 9- Repeat steps 2 to 8 for each pre-assembled length of mast to install, as required and allowed.

Adapter Base for Freestanding Installation (optional)

The optional adapter base for freestanding installation is used when an S Series setup requires a freestanding configuration. Freestanding S Series configurations **are only allowed for standard single unit installations**. For the definition of standard installation, refer to p. 15 of the *Motorized Unit* section.

The weight of the adapter base (2500 lb or 1134 kg) must be considered in the loads applied on the support surface. Refer to the *Minimum Bearing Surface Capacities* table, fig. 1.20, p. 14 for guidance.

Installation of the adapter base

- 1- Installation should be carried out by qualified erectors/dismantlers under the supervision of a competent person, in accordance with all applicable local regulations.
- 2- In reference to the plan/layout drawing, make sure that all the components required are available. Establish the position of the adapter base, determine if there are obstacles and what are the cribbing requirements.
- 3- Before installing the adapter base, determine where the cribbing under the base and jacks will rest (see fig. 8.42). The bearing surface under the cribbing should be level, clear of debris and have the proper bearing capacity (see the *Minimum Bearing Surface Capacities* table, fig. 1.20, p. 14). Should the actual bearing capacity be inferior to the values in the table, please seek instructions and recommendations from Hydro Mobile. It is important to note that **the jacks on the adapter base are designed to level the motorized unit and must not be used to support the load nor the motorized unit**.

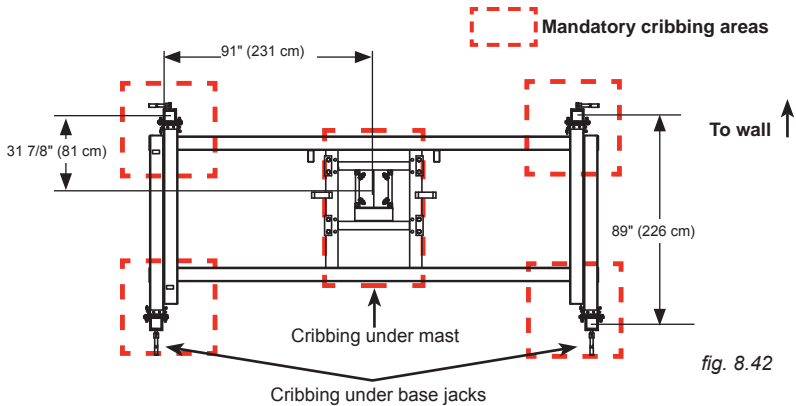

fig. 8.42

Installation of the motorized unit on the adapter base

- 1- Make sure the adapter base is installed properly, as described in the installation instructions above.
- 2- Make sure that there is one mast section installed on the motorized unit and that the mast heads are in place.
- 3- Using a rough terrain forklift or a crane, support the motorized unit by the rear mast head or the D-rings located at the back of the main trolley. For instructions on lifting the motorized unit, refer to p. 112 of the *Transport, Storage and Maintenance* section. It is important to note that the motorized unit **cannot be lifted by a rough terrain forklift using the forklift tubes** on the main trolley.

The unit must be lifted and moved with extreme precaution, making sure the power cable remains clear of obstacles and is never too taut.



WARNING

The forklift tubes on the main trolley cannot be used to lift the unit when a mast section is in place.

Adapter Base for Freestanding Installation (optional)

Installation of the motorized unit on the adapter base

- 4- Remove the 3/4" bolt assemblies to take away both lateral extensions from the base of the motorized unit.
- 5- Lift the motorized unit and carefully lower it on the adapter base for freestanding installation, making sure to align it properly.
- 6- **Still holding the motorized unit**, raise the unit until it is halfway up the second mast section.
- 7- Secure the base of the motorized unit to the adapter base using the 1" (GR8) bolt assemblies (8) supplied with the plates on the adapter base. Tighten the bolts to 60 lb-ft (80 N-m) of torque.



The S Series base is assembled with 3/4" bolt assemblies while the adapter base for freestanding installation is assembled with 1" bolt assemblies (8). It is recommended to have the appropriate tools at hand when removing the lateral base extensions and assembling the adapter base for freestanding installations.



fig. 8.44

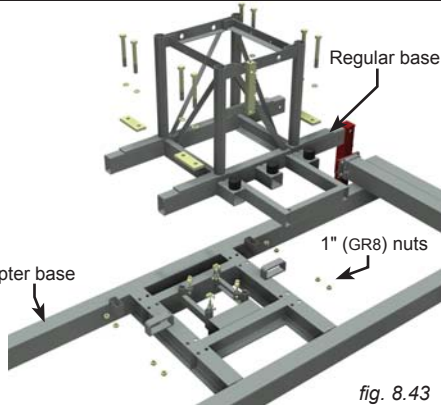

fig. 8.43

- 8- Once the base is secured, release the motorized unit. Make sure the mast guards are put back into place.
- 9- Proceed with the installation of the unit by following the instructions for a standard single unit configuration starting on p. 16 of the *Motorized Unit* section. Make sure that the outriggers on the adapter base are extended according to the height of the mast, as is required and allowed. Refer to the *Authorized Height of Freestanding Installation* table (fig. 8.43) as a guide for the appropriate extension of the outriggers.

Authorized Height for a Freestanding Installation with Adapter Base			
		To wall →	
	Back		Front
Ref	Length of base outrigger extension	Maximum height of mast	Maximum number of planks
A	10" (25 cm)	28' (9 m)	4
B	20" (51 cm)	38' (12 m)	4
C	30" (76 cm)	48' (15 m)	4

fig. 8.45

Jib Arm (optional)

The optional S Series jib arm is used to install or remove mast sections. The jib arm can be used with an interchangeable manual or electrical winch. With a maximum lifting capacity of 400 lb (182 kg), the jib arm must not be used to lift any material other than **one mast section at a time**. Furthermore make sure that mast sections are equally distributed at all times on either side of the mast so the structure is not thrown out of balance.

Installation

- 1- With the motorized unit at base level, remove the toggle pin and lift the cover plate of the jib arm pocket on the main frame of the motorized unit (fig. 8.46).
- 2- Slide the jib arm assembly into the jib arm pocket until it completely covers the pivot pin on the jib arm support plate, inside main frame (fig. 8.47).
- 3- Attach the mast handler to the cable hook at the upper end of the jib arm (fig. 8.48).
- 4- Insert the mast handler at a cross angle under the top bar of the mast section and raise the mast section with the jib arm on top of the bottom mast section. Bolt the mast section in place (see p. 74 of the *Mast and Mast Ties* section).
- 5- Remove the mast handler from the top of the mast section **before** raising the platform.
- 6- Repeat steps 4 and 5 for each mast section to be installed until the setup is complete. Make sure to install mast ties as required and prescribed. For more information about mast ties, refer to p. 76 of the *Mast and Mast Ties* section.
- 7- Make sure the mast heads are installed on top of the last mast section of the setup or that the last mast section of the setup has only **one rack** and is installed **backwards**.
- 8- Once the setup is complete and the motorized unit has been brought back to base level, remove the mast handler and the jib arm.
- 9- Replace the cover plate on the jib arm pocket.

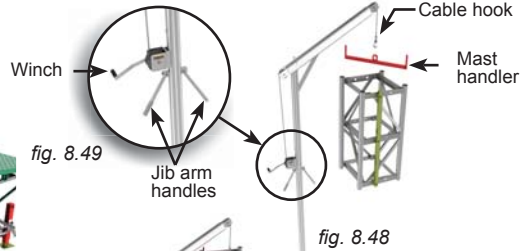
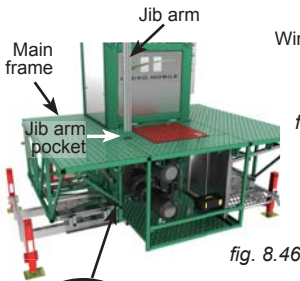

fig. 8.46

fig. 8.49

fig. 8.48

fig. 8.50



WARNING

The jib arm has a maximum lifting capacity of 400 lb (182 kg) and must not be used to lift any material other than **one mast section at a time**. It is also important to remove the mast handler from the top of the mast section **before** raising the platform.

Hoist Support Assembly (optional)

The optional hoist support assembly can be installed on S Series bridges and is designed to be used with an electric hoist with a maximum lifting capacity of 1000 lb (454 kg) (lifting capacity based on a hoist weighing 250 lb or 113 kg).

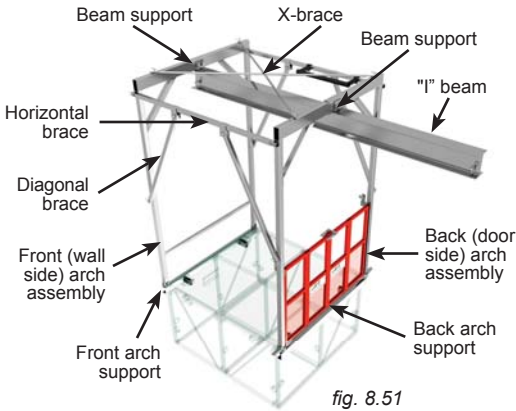

fig. 8.51

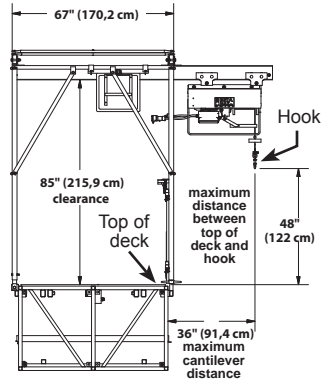

fig. 8.52

Installation

- 1- The hoist assembly must be installed on the first bridge closest to the motorized unit. Refer to p. 92 and p. 93 of the *Load Capacities* section for more information on the allowed location and load capacities of a hoist and its support assembly.
- 2- Insert the back arch support (fig. 8.51) into the outrigger pockets on the bridge. Do not tighten the outrigger pocket bolts completely at this point.
- 3- Insert the front arch support in the outrigger pockets on the bridge. Do not tighten the outrigger pocket bolts completely at this point.
- 4- Slide the back side arch assembly onto the threaded rods of the back arch support.
- 5- Slide the front side arch assembly onto the front arch support. Insert the pivot bolts into the forks to secure the arch in place. Make sure the locking bolts are in place.
- 6- Install the two horizontal braces on top of the mounting pins to link the front and back arches together. Secure the braces to the arches with hitch pins.
- 7- Install the four diagonal braces to make the assembly more rigid. Secure the braces to the horizontal braces and to the arches with hitch pins.
- 8- Slide the I beam in the assembly and secure to the front and back arches with bolt assemblies. Make sure to use a 9' (2,7 m) W6x9 beam.
- 9- Install the X-brace over the mounting pins on top of the assembly. Secure to the front and back arches with hitch pins.
- 10- Make sure the assembly is plumb on all its axis, front and back. **Tighten all bolt assemblies properly.**
- 11- Install the electrical hoist (not supplied) as per the manufacturer's instructions.

Monorail (optional)

Using the same support structure as the weather protection system, the monorail system allows loads of up to 1000 lb (454 kg) to be moved safely along the installation. The monorail system can be used on setups with a maximum planking configuration of three planks wide. The weight of the monorail structure and its accessories must be deducted from the load capacities of the setup. Refer to the *Load Capacities* section on p. 84 to avoid overloading the platform.

Safety guidelines

- 1- The use of a monorail is not allowed on a freestanding installation. It is also important to consider that the combined use of equipment and accessories may not be allowed on a same installation. Refer to the *Combination of Standard and Non Standard Configurations* table in fig. 1.23, p. 15 for more information on the combinations allowed.
- 2- An installation requiring the use of a monorail must be tied to the face of the work. In addition, tie levels must be installed all the way to the top of the installation before the start of any work. Traveling above the last tie point is not allowed in an installation equipped with a monorail.
- 3- Refer to p. 80 of the *Mast and Mast Ties* section for more information about wind speeds and to p. 77 for the appropriate schedule of installation of tie levels for a setup equipped with a monorail.

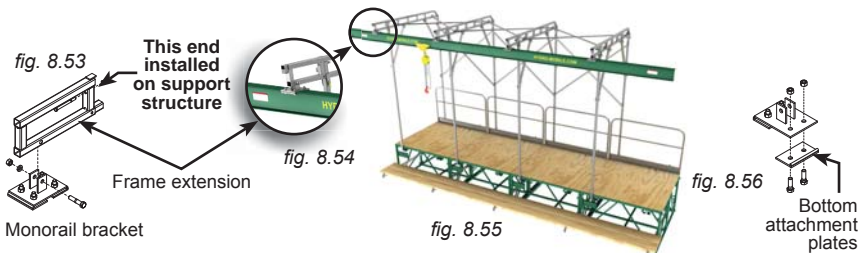

Installation

- 1- To install the monorail support structure, follow steps 1 through 5 of the installation instructions for the weather protection structure, on p. 108 of this section.
- 2- Insert the connecting tube of the frame extension in the bottom tube of the top part of the support structure. Secure in place with a bolt assembly.
- 3- Loosen all four bolts on a monorail bracket (fig. 8.55) to slacken the attachment plates on the bottom. Bolt the monorail bracket to the frame extension installed in step 2.
- 4- Repeat steps 2 and 3 for each monorail beam attachment assembly required by the installation (combination of a frame extension and a monorail bracket).
- 5- Once all monorail beam attachments are secure, slide the top of monorail beams between the attachment plates on the monorail brackets, using monorail beam plates to join beams together.
- 6- Secure the monorail beams in place by tightening the four bolts holding the attachment plates on each of the monorail brackets.
- 7- Make sure that the monorail beam does not overhang by more than 4' (1,2 m), as shown in fig. 8.57.
- 8- Slide the trolley on the monorail beam.

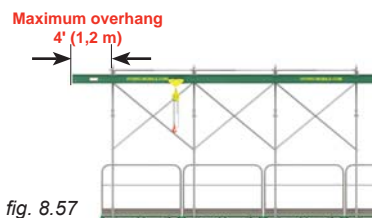

Maximum capacity of 1000 lb (454 kg)

Weather Protection for Bridges (optional)

Weather protection can increase work efficiency by protecting workers, material and equipment against adverse climatic conditions. A weather protection structure allows users to fasten tarpaulins quickly.

The weight of the weather protection structure and its accessories must be deducted from the load capacities of the setup. Refer to the *Load Capacities* section on p. 84 to avoid overloading the platform. It is **mandatory** to read and understand the safety guidelines before installing weather protection.

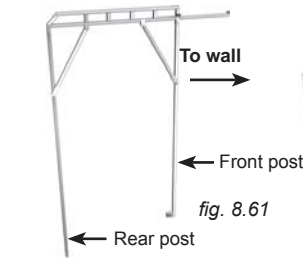

fig. 8.61

Weather protection support frame – dead weight of 100 lb (45,4 kg)

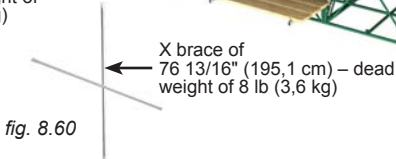

fig. 8.60

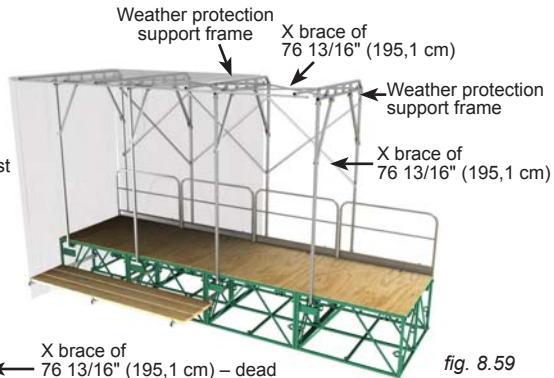

fig. 8.59

X brace of 76 13/16" (195,1 cm) – dead weight of 8 lb (3,6 kg)

Safety guidelines

- 1- The use of weather protection is not allowed on a freestanding installation. It is also important to consider that the combined use of equipment and accessories may not be allowed on a same installation. Refer to the *Combination of Standard and Non Standard Configurations* table in fig. 1.23, p. 15 for more information on the combinations allowed.
- 2- Weather protection is allowed only in a standard configuration.
- 3- An installation requiring the use of weather protection must be tied to the face of the work. In addition, tie levels must be installed all the way to the top of the installation before the start of any work. Traveling above the last tie point is not allowed in an installation equipped with weather protection.
- 4- The use of weather protection is not allowed when wind speeds exceed 28 mph (45 km/h).
- 5- Weather protection must not be used when work is performed on an open air structure.
- 6- When not in use, a platform equipped with weather protection must be brought down to base level.
- 7- Refer to p. 77 of the *Mast and Mast Ties* section for the appropriate schedule for the installation of tie levels for a setup equipped with weather protection.

Installation

- 1- Insert the front post of a support frame in the guardrail pocket of the bridge. Secure in place with a toggle pin and tighten the pocket bolt.
- 2- Insert the rear post of the support frame in the tube behind the guardrail on the other side of the bridge (fig. 8.60).
- 3- Repeat steps 1 and 2 to install a support frame on the following bridge.
- 4- Secure the two support frames by installing X-braces (fig. 8.60) on top and in the back of the structure.
- 5- Repeat steps 1 through 4 to install a support structure every 5' (1,5 m). In a cantilever configuration, the last frame installed will be on the 30" (76 cm) bridge attached to the unit.

Cable Trolley (optional)

On a mast with a height over 150' (45,7 m), the use of the **optional cable trolley kit** is strongly recommended. The following installation instructions are for a right-handed installation.

Installation

- 1- Select the appropriate power cable for the height of the mast. Refer to the *Power Cable Selection Chart* (fig. 4.2, p. 60) for help with the selection of the power cable. Make sure that the overall length of the cable is sufficient for the installation (height of mast, distance from power source, acceptable overall slack in cable).
- 2- Remove the three aluminum panels located on the main trolley: one panel located on the side opposite to the control panel, one panel located behind the mast and one under the electric panel.
- 3- Insert the motorized unit cable support bracket on the bottom horizontal tube of the main trolley that is located on the side opposite to the control panel at a distance of 15.5" (39,4 cm) from the front vertical tube (fig. 8.62). Secure the support in place with a bolt.

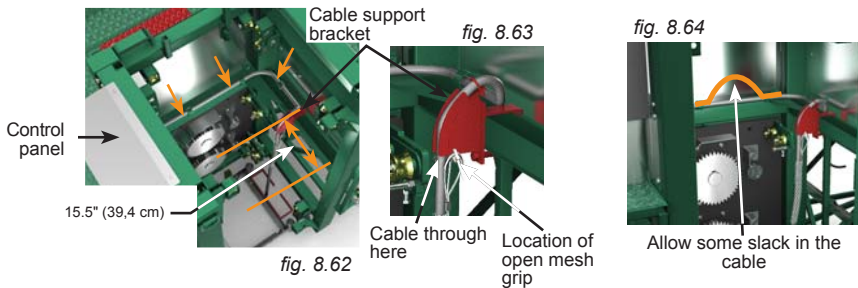

- 4- Run the power cable through the bottom of the main trolley and through the cable support. Then run the power cable along the bottom tubes of the main trolley around the back of the unit then to the control panel. Secure the cable to the main trolley tubes. Secure the cable to the cable support using the open mesh grip, making sure the length of the cable is sufficient for a proper hookup to the control panel and that the cable is not too taut.
- 5- Hook up the power cable to the control panel. This installation must be performed by a certified electrician.
- 6- Allow some slack in the cable behind the mast (fig. 8.64) to be able to adjust the tautness later.
- 7- Tie the cable to the chain links welded on the tubes of the main trolley. Tie the cable to the cable support bracket using the U-bolt provided.
- 8- Install the open mesh grip on the cable, making sure that the cable is not taut between the U-bolt and the open mesh grip. Hang the open mesh grip on the cable support bracket installed on the motorized unit.
- 9- Determine the operational length of the cable ("L1") by calculating the distance between the bottom part of the main trolley and the intended maximum height of the installation.

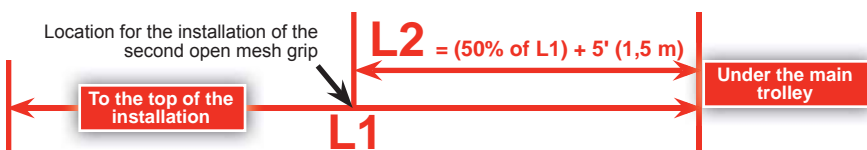

fig. 8.65

Cable Trolley (optional)

Installation (cont'd)

- 10- Determine the location for the installation of the second open mesh grip by calculating the distance ("L2") corresponding to the operational length of the cable ("L1") PLUS 5' (1,5 m) (see fig. 8.65, p. 109). Install the second open mesh grip at that location on the cable.
- 11- Hook the free end of the cable ("3", fig. 8.68) to an appropriate power source. This installation must be performed by a certified electrician.
- 12- Loop the cable at the location of the second open mesh grip. Insert the loop through the lower part of the main trolley.
- 13- Temporarily hook the second open mesh grip on the top horizontal tube of the main trolley (fig. 8.66). Some S Series units are equipped with a chain link welded to the top horizontal tube (shown in red in fig. 8.66) that can be used to hook the open mesh grip.

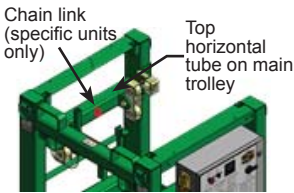

fig. 8.66

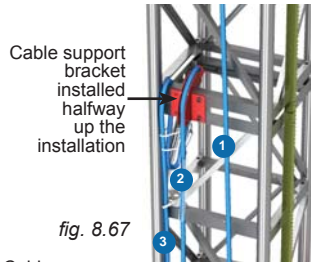

fig. 8.67

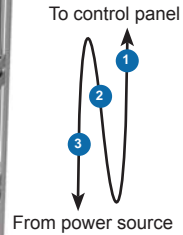

fig. 8.68

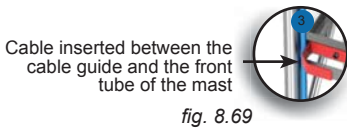

fig. 8.69

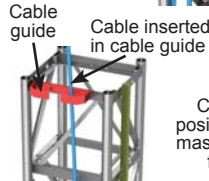

fig. 8.70

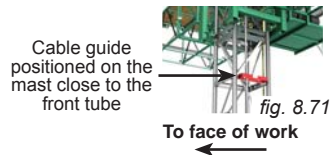

fig. 8.71

- 14- Make sure that cable segments 1 and 2 (fig. 8.67) are properly aligned for passing through the cable guides that will be installed on the whole length of the mast. Make sure also that segment 3 is properly inserted between the cable guide and the front tube of the mast (fig. 8.69).
- 15- Position the first cable guide on the middle bar of the second mast section, making sure it is positioned on the structure to be close to the tube located on the front of the mast (fig. 8.69), toward the face of the work. Secure in place with bolt assemblies.
- 16- Raise the motorized unit and install all the required, subsequent cable guides at every tie level, making sure that segments 1 and 2 of the cable (fig. 8.68) are properly inserted in each cable guide.
- 17- Continue raising the motorized unit until it has reached the junction between two mast sections that is located directly above the halfway mark of the final mast height (determined as "L2" in step 10). For example, if the final mast height will be 300' (91,4 m), the halfway mark will be the junction located directly above the 150' (47,2 m) mark.
- 18- Secure the halfway cable support bracket over the junction between two mast sections located directly above the halfway mark (fig. 8.67). Secure the support in place with bolt assemblies.
- 19- Unhook the cable from the horizontal tube on the main trolley (see step 13). Loop the portion of cable coming from the power source ("3", fig. 8.68) inside the mast section.
- 20- Run a portion of the cable going to the control panel ("2", fig. 8.67) through the support. Secure the cable in place with the U-bolt, making sure to allow some slack in the cable between the U-bolt and the open mesh grip.

Cable Trolley (optional)

Installation (cont'd)

- 21- Lower the unit toward base level. On the way down and at every other mast section, secure the segment of cable coming from the power source ("3", fig. 8.67, p. 110) to the horizontal bar of the mast section. Make sure to secure the cable close to the tube located on the front of the mast (fig. 8.72) so it can be properly inserted in the space between each cable guide and the tube located on the front of the mast.
- 22- Make sure that the cable segments going to the control panel ("1" and "2", fig. 8.67, p. 110) is properly inserted in each cable guide (fig. 8.70, p. 110).
- 23- Lower the motorized unit until it is about 6' (1,8 m) above base level.
- 24- Remove the bolt assemblies and bushings from the cable trolley (fig. 8.73).
- 25- Remove the snap ring to take out the wheel shaft and the guide wheel at one end of the cable trolley assembly (fig. 8.73).
- 26- Align the cable trolley with the mast so the pulley is in line with the power cable.

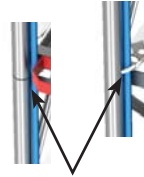

fig. 8.72

Cable is secured to the horizontal bar close to the front tube of the mast section so it can be inserted between the tube and each cable guide

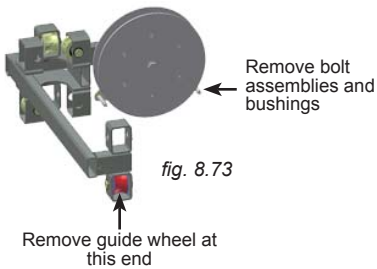

fig. 8.73

Remove guide wheel at this end

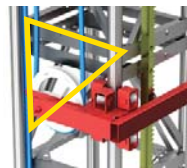

fig. 8.74

Tilt the assembly to facilitate the insertion of the pulley

Make sure this end is properly snug against the structure and reinstall the guide wheel once the assembly is in place

- 27- Tilt the assembly toward the inside of the mast so the pulley can be inserted in the opening between the tube on the front of the mast and the diagonal brace inside and the wheel guides can be properly snug against the mast tube (fig. 8.74).
- 28- Loop cable segments 1 and 2 (fig. 8.67, p. 110) around the pulley and let the cable trolley hang by gravity.
- 29- Reinstall the bushings and bolt assemblies to hold the cable in place, and reinstall the guide wheel (fig. 8.73).
- 30- To avoid crushing the cable trolley when bringing the unit down to base level, bolt the stopper (fig. 8.75) under the main trolley, in line with the buffers on the base.
- 31- Adjust the height of the bottom limit switch to make sure that when the motorized unit stops above the cable trolley when descending, there is at least a 3" (7,6 cm) clearance between the bottom of the stopper and the buffers on the base.
- 32- If necessary, make the required adjustments if the cable around the cable trolley becomes too loose or too tight.
- 33- Raise the motorized unit to the top of the installation, making sure along the way that the cable uncoils properly and is passing through each cable guide installed along the mast. On the way up, install all required, subsequent cable guides at each tie level between the halfway mark and the top of the installation.
- 34- Lower the motorized unit to base level and reinstall the panels removed in step 2.

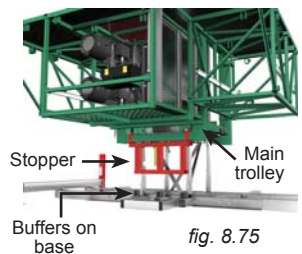

fig. 8.75

Stopper
Main trolley
Buffers on base

Transport and Storage

Preparation of the motorized unit

- 1- Follow the dismantling guidelines appropriate to the installation. Refer to p. 29 of the *Motorized Unit* section for more information on dismantling an installation.
- 2- Make sure the motorized unit is at base level. Push in all the outriggers and lock them in place.
- 3- Remove all motorized unit guardrails and store them in the appropriate storage location (fig. 8.1 and fig. 8.5, p. 114). Secure them in place properly.
- 4- Remove the access stairs, railings and door guardrail and store each component in the appropriate storage location (fig. 8.1 and fig. 8.5, p. 114). Secure all components properly.
- 5- Loosen the bolt of the bottom limit switch trigger located on the last (bottom) mast section and lower the switch trigger all the way down.
- 6- Disconnect the power cable. **This must be performed by a certified electrician.**
- 7- Using the emergency descent, lower the motorized unit until it rests on the rubbers (3) mounted on the base. Make sure there is no load left on the gears or on the output shaft of the gear box.

Lifting and moving of a motorized unit

The lift and relocation of an S Series motorized unit or setup must be carried out with extreme care, using proper certified lifting equipment.

It is **mandatory** to refer to and comply with the capacities and limitations of the lifting device as specified by the manufacturer. It is important to consider that an S Series motorized unit that must be lifted has a total weight of 6750 lb (3062 kg).

Lifting by the forklift tubes

This method can be used to lift and transport a **motorized unit only**.

- 1- Prepare the motorized unit as described in the preparation instructions above. Make sure that there is no mast section installed and that all mast guards are removed.
- 2- Insert the forks in the forklift tubes located at the top of the main frame at the back of the motorized unit (fig. 8.1).
- 3- Lift and transport the motorized unit over to its destination area.

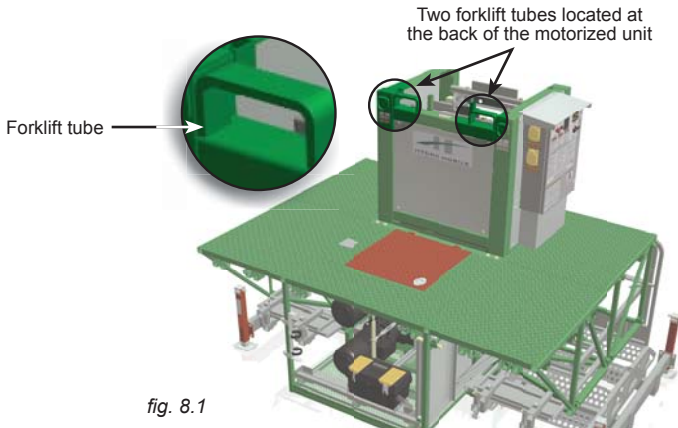

fig. 8.1



WARNING

It is **mandatory** to refer to and comply with the capacities and limitations of the lifting device as specified by the manufacturer. It is important to consider that an S Series motorized unit that must be lifted has a total weight of 6750 lb (3062 kg).

Transport and Storage

Lifting and moving of motorized unit or a setup

Lifting by the D-rings

This method can be used to lift and transport a motorized unit or a cantilever setup with a maximum width of 50' (15,2 m) and a maximum height of mast of 18' (5,5 m). Any cantilever setup being lifted and transported must be of **equal length on either side of the mast**.

- 1- Prepare the motorized unit as described in the preparation instructions on p. 112. Make sure that all the mast guards are removed.
- 2- Slip chains or slings through each of the two D-rings located at the top of the main trolley at the back of the motorized unit (fig. 8.2). Secure the chains or slings to the forks of a rough terrain forklift. Make sure to use an appropriate forklift attachment to secure the chains or slings (shown in red in fig. 8.3).
- 3- Make sure that two workers, wearing proper personal protection (PPE), are standing on the ground using tag lines to help stabilize the structure during the lift, transport and landing of the motorized unit or setup.
- 4- Lift and transport the motorized unit or setup over to its destination area.

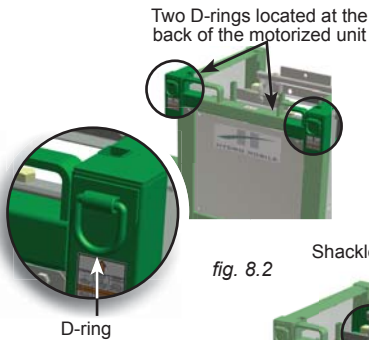

fig. 8.2

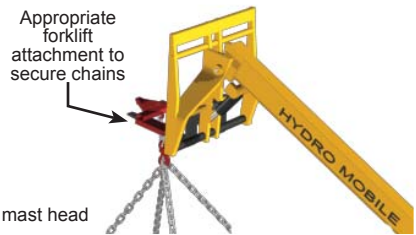

fig. 8.3

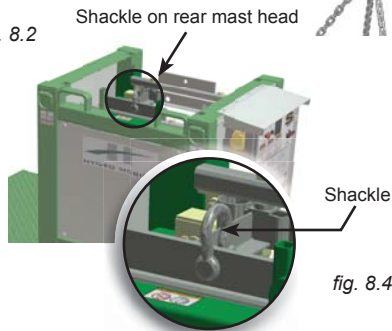

fig. 8.4

Lifting by the rear mast head

This method can be used to lift and transport a motorized unit or a cantilever setup with a maximum width of 50' (15,2 m) and a maximum height of mast of 18' (5,5 m). Any cantilever setup being lifted and transported must be of **equal length on either side of the mast**.

- 1- Prepare the motorized unit as described in the preparation instructions on p. 112. Make sure that all the mast guards are removed.
- 2- Slip a chain or sling through the shackle of the rear mast head located at the back of the motorized unit (fig. 8.4). Secure the chain or sling to the forks of a rough terrain forklift. Make sure to use an appropriate forklift attachment to secure the chain or sling (shown in red in fig. 8.3).
- 3- Make sure that two workers, wearing proper personal protection (PPE), are standing on the ground using tag lines to help stabilize the structure during the lift, transport and landing of the motorized unit.
- 4- Lift and transport the motorized unit or setup over its destination area.

Transport and Storage

Storage of guardrails and access stairs

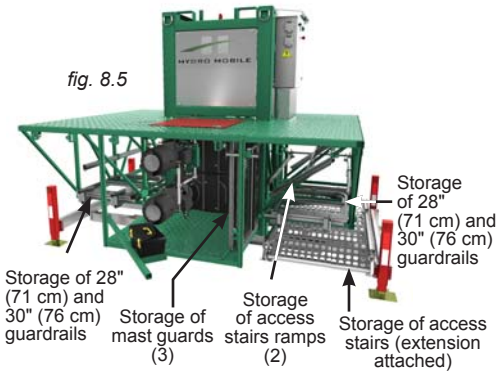

The hinged tube holding the toolbox at the back of the main frame must be pulled open to facilitate access to the mast guard storage area. The plank-end guardrails (2) can also be stored horizontally on the main frame bottom plate, under the motors. It is recommended to proceed with caution when handling objects around the motors.

Storage of a bridge

- 1- Inspect the structure of the bridge, including the inside of the open-end tubes, for any sign of damage or distortion. Clean the bridge and its components thoroughly to limit the effects of any corrosive agent.
- 2- Bridges must not be stored directly on the ground. Make sure to place sufficient cribbing under the bottom chords to prevent damages to the bottom of the structure.
- 3- Avoid storing the bridge in a location with direct exposure to aggressive or corrosive materials in the surroundings.

Storage of the motorized unit

- 1- Inspect the structure of the motorized unit for any sign of damage or distortion. Clean the motorized unit thoroughly to limit the effects of any corrosive agent.
- 2- Before storing the motorized unit, make sure to place sufficient cribbing under the base to prevent damages to the bottom of the structure.
- 3- Choose an appropriate storage location. Avoid storing the motorized unit in an environment where temperatures fluctuate within the range of 32°F and 104°F (0°C and 40°C) and where relative humidity is in excess of 60%.

Avoid storing the motorized unit in a location with direct exposure to the sun or UV light and aggressive or corrosive materials in the surroundings.

- 4- When **not in use for an extended period**, the motorized unit must be **moved up and down for 10 minutes every 60 days** to allow the oil to warm up while circulating within the gear case. This will ensure a proper internal lubrication and avoid damages to the internal components and to the oil seals on the output shaft.

WARNING



When storing a motorized unit, there should be sufficient cribbing under the base to prevent damages to the bottom of the structure.

When not in use for an extended period, the motorized unit must be **moved up and down for 10 minutes every 60 days** to allow the oil to warm up while circulating within the gear case.

Inspections and Maintenance

Proper maintenance and service will warrant safe, economical, and trouble-free operation of an S Series motorized unit and its accessories. In order to ensure operational safety and avoid failures, the owner and/or user must make sure that all the scheduled inspection and maintenance operations have been effectively and timely carried out according to the inspection and maintenance schedules recommended for S Series motorized units and their accessories.

Blank copies of the daily inspection checklist must be available on job sites at all times to be filled out when daily and weekly inspection operations are carried out. Maintenance and inspection logs must be kept on record for warranty and safety purposes.

Copies of all maintenance and inspection checklists can be obtained by contacting the distributor/service center or the Hydro Mobile technical support team or downloaded directly from the Hydro Mobile website at www.hydro-mobile.com.

Greasing of gears and rack

A proper and timely greasing of the gears and the rack is critical to guarantee performance and longevity of the Hydro Mobile S Series mast climber system. It is important to understand that not all open gear greases and lubricants offer equal levels of quality and performance. Consequently, only open gear grease approved by the Hydro Mobile Engineering department should be used on Hydro Mobile equipment.

Application frequency must be based on the installation and the cumulative runtime use of the equipment. However, the gears and racks should typically be greased after **every 8 to 10 hours of operation** (with unit traveling up and down the mast).

Gears and racks on a typical mast climber with a duty cycle of 25% will require to be greased on a weekly basis.

$$8 \text{ hrs/day} * 5 \text{ days} * 25\% \text{ duty cycle} = 10 \text{ hrs}$$

Higher duty cycle operation will require greasing to be more frequent. For example, use of the S Series mast climber in a transport platform application in 100% duty cycle will **increase greasing requirements** to up to once a day.

Grease must be applied to the rack and gears **at the end of the working shift**, from the **top of the mast down**. **Grease must be allowed to stand for 2-3 hours** before the motorized unit is used again. Use an open gear lubricant recommended by Hydro Mobile.

Old grease expelled out of the gear meshing should be **cleaned off** on a regular basis. The rack should be visually inspected at the end of each working shift and grease should be applied if needed.

Recommended open gear lubricants	
Manufacturer	Part number
Prolab	OG-700
Petron Corporation	Gear Shield NC

Inspections and Maintenance

Daily and Weekly Inspections and Maintenance

Each Hydro Mobile motorized unit and its accessories must be submitted to daily (or before every working shift) and weekly inspections and maintenance operations performed by the qualified user/operator. For more information about a qualified user/operator, refer to p. 5 of the *Performance and Safety Rules* section.

Daily and weekly inspection operations are only necessary when the motorized unit and its accessories are in use. The owner and/or user is responsible for all inspection and maintenance operations. Before being first used on a job site, an S Series motorized unit and its accessories must be inspected effectively and timely, according to the schedules recommended for S Series motorized units and their accessories.

Maintenance and inspection logs must be kept on record for warranty and safety purposes. Blank copies of the daily inspection checklist must be available on job sites at all times to be filled out when daily and weekly inspection operations are carried out. The notes and comments form must be used to indicate any discrepancy or any item found to be not acceptable. Any discrepancy must be reported to the owner/user and appropriate corrective action must be taken immediately. Corrective actions must be performed by qualified personnel.

Frequent Inspections and Maintenance

Frequent inspections must be performed by a qualified technician. For more information about qualified technicians, refer to p. 5 of the *Performance and Safety Rules* section.

Each Hydro Mobile motorized unit must be submitted to a frequent inspection performed every three months by a qualified technician.

Maintenance and inspection logs must be kept on record for warranty and safety purposes. Blank copies of the frequent inspection checklist must be filled out when frequent inspection operations are carried out. The notes and comments form must be used to indicate any discrepancy or any item found to be not acceptable. Any discrepancy must be reported to the owner/user and appropriate corrective action must be taken immediately. Corrective actions must be performed by a qualified technician. For more information about qualified technicians, refer to p. 5 of the *Performance and Safety Rules* section.

All inspection and maintenance steps included in the daily inspection checklist must be performed before the frequent inspection and maintenance steps.

It is recommended to use replacement parts manufactured by or recommended by Hydro Mobile. The use of substitute parts could not only void the warranty covering this motorized unit and its components but cause serious damages that could lead to injury or death. It is recommended to replenish and grease components only with fluids and lubricants recommended by Hydro Mobile.

Annual Inspections and Maintenance

Annual inspections must be performed by a qualified technician. For more information about qualified technicians, refer to p. 5 of the *Performance and Safety Rules* section.

Each Hydro Mobile motorized unit must be submitted to an annual inspection performed by a qualified technician. This annual inspection must be carried out no later than 13 months after the previous annual inspection.

Maintenance and inspection logs must be kept on record for warranty and safety purposes. Blank copies of the annual inspection checklist must be filled out when annual inspection operations are carried out. The notes and comments form must be used to indicate any discrepancy or any item found to be not acceptable. Any discrepancy must be reported to the owner/user and appropriate corrective action must be taken immediately. Corrective actions must be performed by a qualified technician. For more information about qualified technicians, refer to p. 5 of the *Performance and Safety Rules* section.

It is recommended to use replacement parts manufactured by or recommended by Hydro Mobile. The use of substitute parts could not only void the warranty covering this motorized unit and its components but cause serious damages that could lead to injury or death. It is recommended to replenish and grease components only with fluids and lubricants recommended by Hydro Mobile.

Inspections and Maintenance

Copies of inspection and maintenance checklists shown below can be obtained by contacting the distributor/service center or the Hydro Mobile technical support team or downloaded directly from the Hydro Mobile website at www.hydro-mobile.com.

Daily inspection checklist

The form is titled 'DAILY INSPECTION CHECKLIST' and includes sections for 'General Information', 'Pre-Start Checks', 'Operational Checks', and 'Post-Start Checks'. It features a large grid for recording inspection results with columns for 'Inspected', 'Status', and 'Remarks'.

fig. 8.7

Frequent inspection checklist

The form is titled 'FREQUENT INSPECTION CHECKLIST' and includes sections for 'General Information', 'Pre-Start Checks', 'Operational Checks', and 'Post-Start Checks'. It features a large grid for recording inspection results with columns for 'Inspected', 'Status', and 'Remarks'.

fig. 8.8

Annual inspection checklist

The form is titled 'ANNUAL INSPECTION CHECKLIST' and includes sections for 'General Information', 'Pre-Start Checks', 'Operational Checks', and 'Post-Start Checks'. It features a large grid for recording inspection results with columns for 'Inspected', 'Status', and 'Remarks'.

fig. 8.9

Copies of the job survey checklist and the handover checklist shown below can be obtained by contacting the distributor/service center or the Hydro Mobile technical support team or downloaded directly from the Hydro Mobile website at www.hydro-mobile.com.

The form is titled 'JOB SURVEY - JOB HAZARD ANALYSIS' and includes sections for 'Job Information', 'Hazard Identification', 'Risk Assessment', and 'Control Measures'. It features a large grid for recording hazard analysis results with columns for 'Hazard', 'Severity', 'Frequency', and 'Control Measures'.

fig. 8.10

The form is titled 'INSTALLATION HANDOVER SHEET' and includes sections for 'General Information', 'Installation Details', 'Handover Checklist', and 'Signatures'. It features a large grid for recording handover details with columns for 'Item', 'Status', and 'Remarks'.

fig. 8.11